



## ARCHITECT<sup>™</sup> MODEL P800

8 CHANNEL MULTI-ZONE POWER AMPLIFIER

# Important Safety Instructions

1. Read these instructions.
2. Keep these instructions.
3. Heed all warnings.
4. Follow all instructions.
5. Do not use this apparatus near water.
6. Clean only with a dry cloth.
7. Do not block any ventilation openings. Install in accordance with the manufacturer's instructions.
8. Do not install near any heat sources such as radiators, heat registers, stoves, or other apparatus (including amplifiers) that produce heat.
9. Protect the power cord from being walked on or pinched particularly at plugs, convenience receptacles, and the point where they exit from the apparatus.
10. Only use attachments/accessories specified by the manufacturer.
11. Unplug this apparatus during lightning storms or when unused for long periods of time.
12. Refer all servicing to qualified service personnel. Servicing is required when the apparatus has been damaged in any way, such as power-supply cord or plug is damaged, liquid has been spilled or objects have fallen into the apparatus, the apparatus has been exposed to rain or moisture, does not operate normally, or has been dropped.
13. This apparatus shall not be exposed to dripping or splashing, and no object filled with liquids, such as vases or glasses, shall be placed on the apparatus.



The lightning flash with arrowhead symbol within an equilateral triangle is intended to alert the user to the presence of uninsulated "dangerous voltage" within the product's enclosure, that may be of sufficient magnitude to constitute a risk of electric shock to persons.



The exclamation point within an equilateral triangle is intended to alert the user of the presence of important operating and maintenance (servicing) instructions in the literature accompanying the appliance.



Caution: to reduce the risk of electric shock, do not remove the top cover. There are no user-serviceable parts inside. Refer servicing to qualified personnel.

This equipment has been tested and found to comply with the limits for a Class B digital device, pursuant to part 15 of the FCC Rules.

These limits are designed to provide reasonable protection against harmful interference in a residential installation.

This equipment generates, uses, and can radiate radio frequency energy and, if not installed and used in accordance with the instructions, may cause harmful interference to radio communications. However, there is no guarantee that interference will not occur in a particular installation.

If this equipment does cause harmful interference to radio or television reception, which can be determined by turning the equipment off and on, the user is encouraged to try to correct the interference by one or more of the following measures:

- Reorient or relocate the receiving antenna.
- Increase the separation between the equipment and the receiver.
- Connect the equipment into an outlet on a circuit different from that to which the receiver is connected.
- Consult the dealer or an experienced radio/TV technician for help.

CAUTION: Changes or modifications to this device not expressly approved by AudioControl Inc. could void the user's authority to operate the equipment under FCC rules.



Recycling notice: If the time comes and this apparatus has fulfilled its destiny, do not throw it out into the trash. It has to be carefully recycled for the good of mankind, by a facility specially equipped for the safe recycling of electronic apparatus. Please contact your local or state recycling leaders for assistance in locating a suitable nearby recycling facility. Or, contact us and we might be able to repair it for you.

# Table of Contents

|  |    |
|--|----|
| <b>Important Safety Instructions</b> . . . . . | 2  |
| <b>Introduction</b> . . . . .                  | 4  |
| Congratulations! . . . . .                     | 4  |
| Features . . . . .                             | 5  |
| Complimentary bullet points. . . . .           | 6  |
| Quick View . . . . .                           | 7  |
| <b>Getting Started</b> . . . . .               | 8  |
| An Important note about Triggering. . . . .    | 8  |
| Home Installation . . . . .                    | 9  |
| Commercial Installation . . . . .              | 9  |
| <b>Front Panel Features</b> . . . . .          | 10 |
| LED Function Table . . . . .                   | 11 |
| Ventilation . . . . .                          | 12 |
| <b>Rear Panel Features</b> . . . . .           | 13 |
| AC section . . . . .                           | 13 |
| Bus A and B Sections. . . . .                  | 15 |
| DIP Switch Function Table . . . . .            | 17 |
| <b>Speaker Connections</b> . . . . .           | 18 |
| Speaker and Wiring Impedance. . . . .          | 19 |
| <b>Troubleshooting</b> . . . . .               | 20 |
| <b>Block Diagram</b> . . . . .                 | 22 |
| <b>Specifications</b> . . . . .                | 23 |
| <b>Service</b> . . . . .                       | 24 |
| <b>The Warranty</b> . . . . .                  | 25 |
| <b>Installation Notes</b> . . . . .            | 27 |
| <b>Basic Cha Cha</b> . . . . .                 | 28 |

# Introduction

When a whole-house audio system demands high levels of audio performance, but the physical installation space is limited, the AudioControl Architect model P800 is an ideal solution. Requiring only one rack space, this 8 channel power amplifier produces plenty of clean high-quality power for your system. Extensive protection features prevent damage to your loudspeakers.

## Congratulations!

You are now installing a component which will dramatically improve the performance of any distributed audio system, especially those utilizing in-wall, in-ceiling, and invisible speakers.

The Architect model P800 8-channel power amplifier provides high levels of power, pristine sound quality, flexible input switching, plus a number of installation-friendly features that make it the perfect product for performance oriented audio systems.

The amplifier is an American-designed and built, “set and forget” component which will provide a lifetime of trouble-free service for your multi-room audio system.

The Architect model P800 is designed and manufactured by AudioControl, the only electronics company in the world that specializes in amplifiers, equalizers, signal processors and audio analyzers. Our passion for high quality, meticulous attention to detail, and pro sound heritage shows itself in the dozens of awards we have won for our designs, products, and service.

Now, as when we began, our greatest satisfaction is our reputation for sonic excellence and reliability among people just like you throughout the world.

This manual is designed to help you get the best out of this amplifier. So, even though you’re wanting to see it in action, please take a few minutes to slog through our not-so-weighty prose and learn how to get the most from your Architect power amplifier.



## Features

Here are some of the features that make the Architect model P800 a very unique product, unlike any other amplifier:

- **Superior Sound Quality**

Pristine sonics happens first in all AudioControl designs and is not compromised by any other feature. (You often get the feeling that sound quality is an afterthought with products from other companies.)

- **High Power Levels**

There are 8 channels of 100 Watts each into 8 Ohms, or 200 Watts into 4 Ohms. Each channel pair can also be run in bridged mono at 400 Watts into 8 Ohms.

Each high-efficiency amplifier is discretely made from discrete components.

- **Bussable Digital and Analog Inputs**

Each zone can select either Bus A, Bus B, or a local input. The Bus A S/PDIF digital input uses a high resolution DAC that converts up to 192 kHz. The digital source is available to play in any zone. The Bus B analog input uses a pair of RCA connectors. The analog source is available to play in any zone. A pair of RCA connectors is also available as a loop output, for example: to share the source with another Architect model amplifier. Each zone has its own local pair of analog input connectors.

- **Unparalleled Energy Efficiency**

Whether from the point of view of saving electricity, or from the view-point of less heat in the rack, the Architect model amplifier has no equal. It is VERY energy efficient during operation, and equally impressive during standby.

- **LightDrive Anti-clipping**

With durability in mind, AudioControl's LightDrive anti-clipping protection defends the system against clipping, distortion, damage, and even teenage parties. The Architect model P800 features the latest evolution of LightDrive which adds a power-supply-tracking instantaneous dynamic control to the smooth sound of the traditional AudioControl LightDrive.

- **Self Resetting Protection Features**

Protection features are extensive and include thermal, short circuit, clipping, ultrasonic and DC offset among others. If the fault is removed, the Architect model P800 resets.

- **Pacific Northwest Heritage**

Hard to believe, but we make this product in the USA. We are very proud of that fact. What is more important is the care we craft in at every step, and the extensive knowledge we have in all aspects of the product. Plus, we back this up with a conditional five year warranty.

---

ARCHITECT™

Models P800

Installation Manual

## Complimentary bullet points

- 8 channels of AudioControl amplification
- Efficient power amplifiers and power supply
- Power consumption is less than 1 Watt in standby
- Rack mountable 1U form factor
- Removable rack ears
- Light weight
- Stackable with other AudioControl Architect and Director Matrix models (maximum of four per stack)
- Signal sense independent for each zone
- Bus assignment independent for each zone
- 40 Hz infrasonic filter independent for each zone
- 12V Trigger independent for each zone, usable with contact closure or 12V external source
- 12V Master trigger
- BUS A S/PDIF input with premium Wolfson digital to analog converter
- BUS B analog input pair with loop-through outputs

# Quick View

## Front Panel

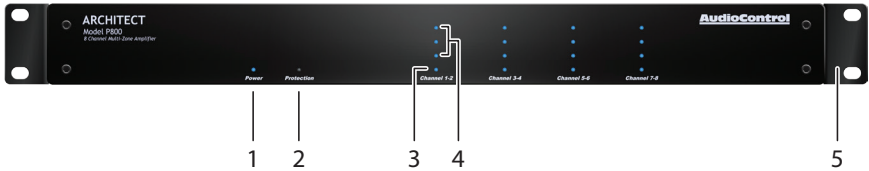

1. Power LED
2. Protection LED
3. Zone Status LED
4. Zone Level LED Ladder
5. Rack Mount Ears

## Rear Panel

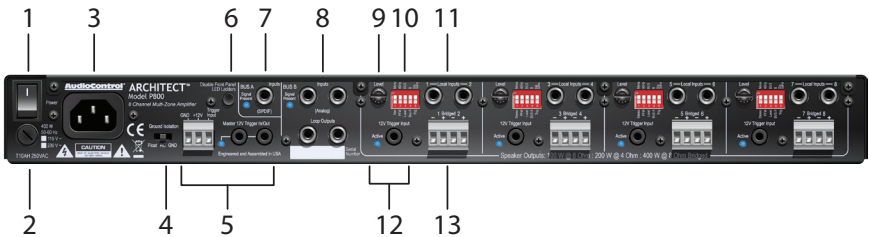

1. AC Power Switch
2. AC Fuse
3. AC Input
4. Ground Isolation Switch
5. Master Trigger
6. Disable Front Panel LED Ladders
7. BUS A Digital Input
8. BUS B Analog Input and Loop Output
9. Zone Level Control
10. DIP Switches
  - 1 Mono/Stereo
  - 2 PFM 40 Hz
  - 3 Local/Bus
  - 4 Bus A/B
  - 5 Signal Sense
11. Local Analog Inputs
12. 12V Local Trigger
13. Speaker Outputs

ARCHITECT™

Models P800

Installation Manual

# Getting Started

1.  Turn off power to all components before making any connections.
2. When making connections, designate red RCA plugs as right, and designate white, black, or grey plugs as left. This is a good idea for all signal connections made in your audio system. The key is consistency. Stick with the same color coding and you'll reduce possible problems.
3. Whenever possible, keep power cords away from signal cables to prevent induced hum. This is especially important if you bundle the cables to keep the installation neat looking.
4. Use quality interconnect cables. We know from experience that really cheap cables can cause a multitude of problems. They tend to break inside or corrode, causing a loss of signal or hum. They also have poor shielding.
5. If you need to run the RCA audio cables more than 20 feet, consider using an active balanced line driver for the signals. This will provide better noise rejection against nasty things like hum, spikes, local talk radio, and metaphysical paranormal phenomena, etc. The AudioControl balanced line driver components (BLD-10, BLR-10 and BLX-10) are an excellent way to send audio over long distances with standard Cat-5 wiring. Check them out at [audiocontrol.com](http://audiocontrol.com).
6. If you are using the Bus A digital input, and running higher resolution sample rates (96 kHz - 192 kHz), use high-quality digital interconnect cables.

## Installation Examples

The next page shows two typical installations of the Architect Model P800.

The first example is a home installation with two separate zones, each playing a different local analog source. One other zone is playing the Bus B analog source, and one is playing the Bus A digital source.

The second example is a bar or restaurant installation where multiple speakers in the main seating area are playing the Bus A digital source, and separate room zones are playing individual local analog sources.

The versatile DIP switches of each zone allow the selection of the local inputs, BUS A input, and BUS B input to play in that zone.

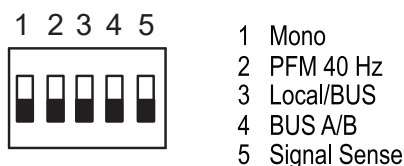

## An Important Note about Triggering

The rear panel master trigger connectors (two TS 1/8" and a 3-pin block) are used to turn on the unit or place it into standby mode.

 If no trigger voltage is present at any of these trigger inputs, then the unit will be in standby, with all zones muted. If you are not using master triggering, then you **must** install a short wire link from the 12V output pin to the trigger input pin of the 3-pin connector.

To put the unit into standby, remove the link.

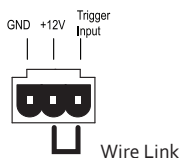



# Home Installation

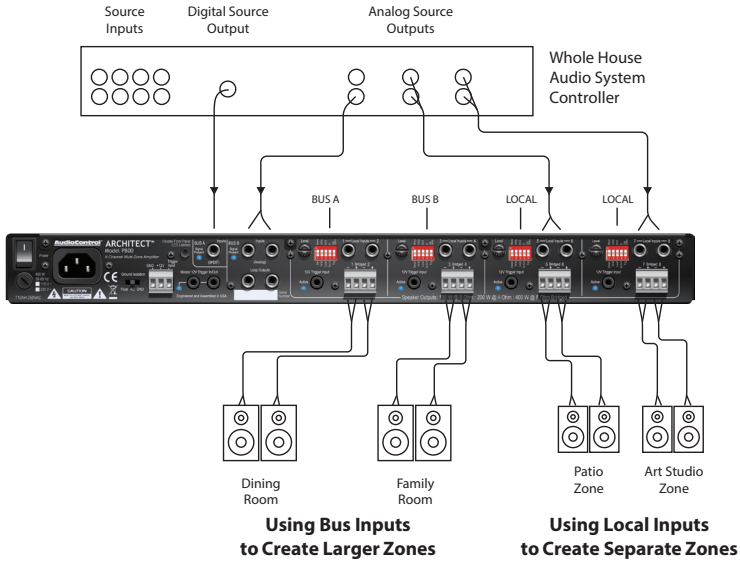

# Commercial Installation

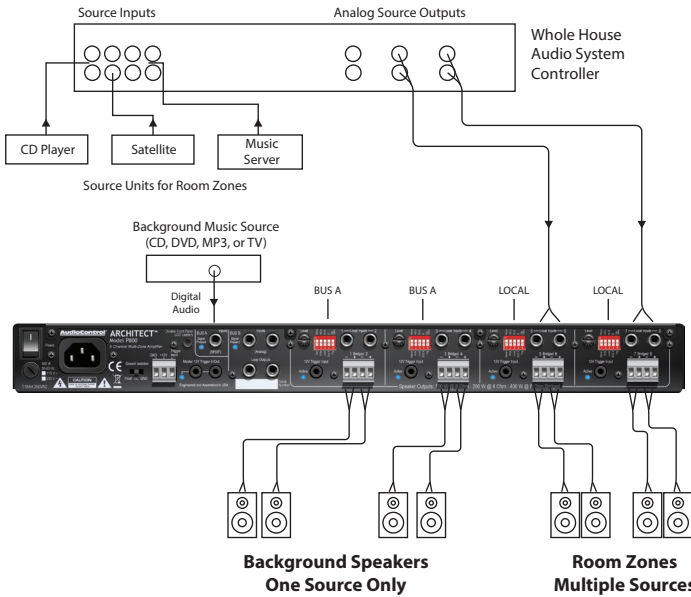

ARCHITECT™

Models P800

Installation Manual

# Front Panel Features

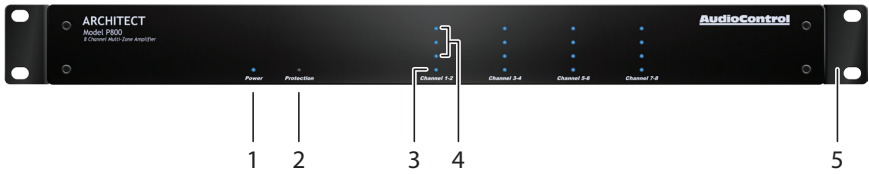

1. **Power LED** – This dual color LED indicates when the unit is in standby, on, or off (see LED table on the next page).

Red: The unit is in standby mode and is ready to be turned on via 12V triggering

Blue: The unit is on

Green: Coffee brewed

OFF: The unit is powered off

2. **Protection LED** – This red LED will illuminate briefly during turn on/off phases, and if a fault is detected in any amplifier or the power supply (such as overheating, over-current, or DC offset). If a fault is detected, then the unit will go into its protection mode to prevent any damage to loudspeakers, and to allow cooling.

3. **Zone Status LED** – This dual-color LED indicates when the zone is in fault mode, active, or in standby.

Red: The zone has detected a fault, such as a DC offset or a load short circuit.

Blue: The zone is active

OFF: The zone is in standby





4. **Zone Level LEDs** – These three LEDs light from the bottom to the top depending on the zone’s output level (-33, -20, -10 dBFS). These LEDs can be defeated by engaging the rear panel switch “Disable Front LED Ladders.”



5. **Rack Mount Ears** – The unit comes supplied with removable rack mount ears. These allow the unit to be rack mounted in a standard 19” wide rack, with a 1U height. Use standard rack mount screws and washers to secure the unit in a rack. The unit does not have to be supported at the rear if the rack is located in a fixed location.

To remove the rack ears (making the unit 17” wide), first unplug the power cord, and then locate and undo the four screws securing each ear to the side of the chassis, and remove the ears. Replace the screws securely back into the chassis. Do not remove any of the other screws from the chassis or top cover. There are hazardous voltages inside the unit. Keep the rack ears carefully wrapped up in a sock under your pillow. Make a wish and the rack ear fairy may come.

## LED Function Table

| LED   | Color | Description  |
|---|-------|--|
| <br><b>Power</b>       | Red   | The unit is in standby mode  |
|   | Blue  | The unit is on   |
|   | Off   | The unit is powered off, or all the lights are off in your town                        |
| <br><b>Protection</b>  | Red   | The unit has detected a fault and is in protect mode*                                  |
|   | Off   | The unit is operating normally, or it is powered off                                   |
| ZONE LEDs   | Color | Description  |
| <br><b>Channel 1-2</b> | Blue  | -10 dBFS zone output level   |
|   | Blue  | -20 dBFS zone output level   |
|   | Blue  | -33 dBFS zone output level   |
| <br><b>Channel 1-2</b> | Red   | The zone has detected a fault, or a smooth-jazz saxophone solo, and is in protect mode |
|   | Blue  | The zone is active   |
|   | Off   | The zone is in standby   |

\*The protection LED also comes on for a short time during power up or down

## Ventilation

This may be as good a time as any to have “the talk” about ventilation. The Architect model P800 features a cool-running efficient switch mode power-supply and Class D amplifiers, and is equipped with thermally controlled fans. This is a powerful 8 channel amplifier, and therefore requires plenty of good ventilation to properly cool.



Please be advised that no more than 4 Architect models may be stacked together. Any more than that, then an empty rack space above and below is required for adequate ventilation.



Review the heat load specifications and ensure that your rack room meets these requirements.

Ideal Spacing 1U rack space or more above and below each pair



If the amplifier should overheat, a thermal sensor will put it into standby mode, allowing the heatsink to cool down. Once the amplifier has cooled to a safe operating temperature, the amplifier will reactivate. If this occurs often, identify the cause of the problem and take corrective action, for example:

Provide additional ventilation

Do not install in a sealed location with limited or no airflow

Install a fan in the rack

Make sure that the amplifiers are not overloaded with speaker impedances below the recommended minimum

Check that there are no short circuits in the speaker cables or speakers.

Note: Each zone will shut off independently when a short circuit is detected.



No more than four units can be stacked without a rack space between them. Allow 1U rack space or more above and below each stack of four.



## Rear Panel Features

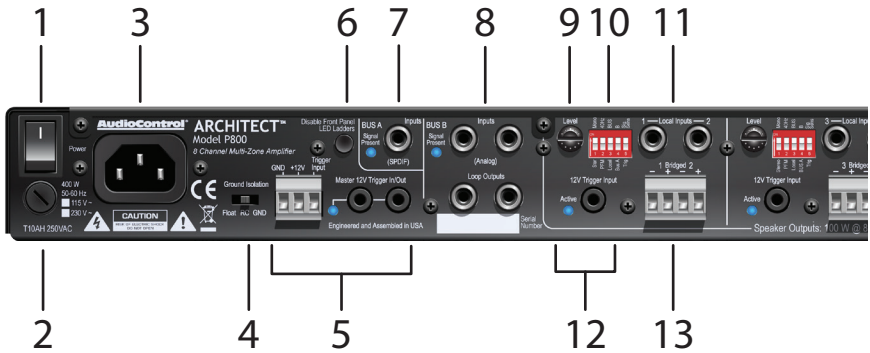

### AC section



When rack-mounting the unit, make sure that the power cord and the AC power switch remain readily accessible.

1. **AC Power Switch** – This switch shuts off the main AC power. Normally the only time you need to turn this off is if the system is going to be shut down for an extended period of time. Use the master trigger inputs to switch the unit between standby and on.

Also turn the power switch off during lightning storms, wind storms with frequent power outages, or closer to the time when a giant robot from space is about to eat the local power sub station.

2. **AC Fuse** – The main power supply fuse may be checked or replaced. Make sure that the power cord is unplugged from the AC mains first. Then use a flat-headed screwdriver to undo the fuse carrier from the fuse holder. Inspect the fuse and replace with the exact same type indicated on the unit.

3. **AC Input** – Connect the supplied AC power cord securely to this input. Plug the other end into an AC mains outlet of the correct voltage rating for your unit. They are either 100 -120 VAC (50 – 60 Hz) or 220 – 240 VAC (50 – 60 Hz); look at the check box to see how your unit has been configured. The voltage setting is not user-settable. This unit is a class 1 device, do not defeat the safety ground connection or use a power cord that does not have the safety ground pin.

ARCHITECT™

Models P800

Installation Manual

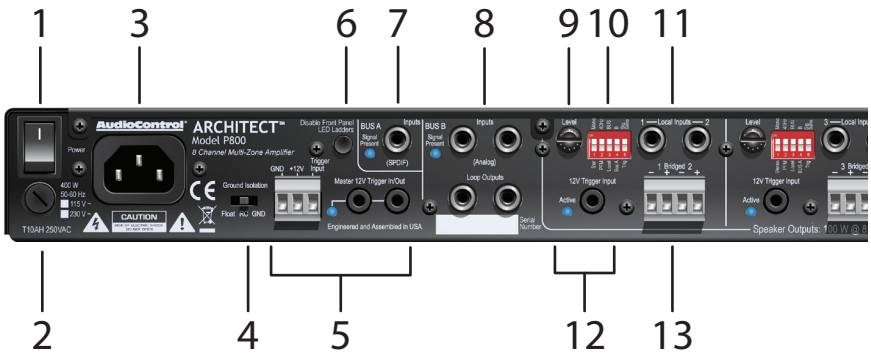

4. **Ground Isolation Switch** – This switch selects the level of isolation between the audio signal ground and the AC earth ground. In normal operation this switch should be in the GND Ground position. If there is trouble with an AC ground hum, try the other two settings for the best operation. For safety, the chassis is always connected to the earth ground regardless of the switch.

5. **Master Trigger** – The TS 1/8" connectors and the 3-pin block connector are used to turn on the unit or place it into standby mode. Any one of these three connections can be used as a trigger input.

If no trigger voltage is present at any of these trigger inputs, then the unit will be in standby, with all zones muted. See the next page for important details if you are not using the master trigger.

**LED indicator** – This LED is blue when the master trigger input is active, and off when it is inactive.

**3-pin connector** – To remotely turn on the unit, use either a contact closure between the Trigger Input and the +12V output, or an external +12V trigger between the Trigger In and GND terminals. The +12V output is

not designed to power other pieces of equipment or jump start your car.

**Pinout:**

- GND Ground
- +12V Output
- +12V Trigger Input

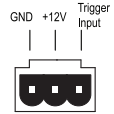

1/8" TS mono jacks – These are wired in parallel to each other, and work in conjunction with the 3-pin connector. Either input can receive a +12V trigger which will turn on the unit. This will then allow the unused jack to output +12V that can be used to turn-on a second unit. If the 3-pin connector is used to trigger the unit, then both of the 1/8" jacks can be used to provide output triggers to other units.

**Pinout:**

- Tip = +12V Trigger Input
- Sleeve = Ground

**Power Up Process:** When a +3 to +12V signal is sensed at the trigger input of either of the 1/8" TS connectors, or the 3-pin connector, the rear panel master trigger indicator LED will change from off to blue. All the zones will be held in standby for about 2 seconds until the power supplies have fully charged and performed their self-tests. During this short process, the front panel Power and Protection LEDs will be red. When complete, the Power LED will turn blue and the Protection LED will turn off.

**Power Down Process:** As soon as a 0V signal is sensed at the master trigger inputs, all zones will be muted and placed in standby, and the rear panel master trigger LED will change from blue to off. The front panel Power LED will remain on, as the main power supplies will be still energized.

If the master trigger Inputs remain at 0V for 2 seconds, the main power supplies will shut off; the front panel Power LED will change from blue to red. The Protection LED will flash red once during the power-down process.

The trigger input is biased towards ground. This keeps the unit in standby when nothing is connected.



If you are not using master triggering, then you **must** install a short wire link from the +12V output to the trigger input. To put the unit into standby, remove the link.

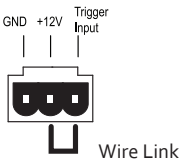

#### To trigger ON with a contact closure:

Connect the contact closure between +12V and Trigger Input

#### To trigger OFF with a contact closure:

Connect a 1 k $\Omega$  resistor between +12V and Trigger Input

Connect the contact closure between Trigger Input and GND

#### To use an external 12V trigger:

Connect the external ground to the Architect model GND

Connect the external +12V output voltage to the Architect model Trigger Input

6. **Disable Front Panel LED Ladders** – The front panel LED ladders show the output levels of each zone. If this is a distraction, or your pets keep getting hypnotized, press this switch in to turn off the LED ladders. This switch does not affect the Power, Protection, or Zone Status LEDs.

## Bus A and B Sections

7. **BUSA Input** – This S/PDIF digital input uses a standard RCA coaxial connector.

The digital signals are converted into two analog channels by the unit's fine internal digital to analog converters. The two audio channels are then available to any zone that has its DIP switch 4 set to Bus A (down), and switch 3 set to Bus (up). (See the next page for a riveting discussion on DIP switches.)

The Signal Present LED lights whenever a signal is present at the Bus A input.

8. **BUS B Input** – This pair of standard RCA coaxial connectors accepts line-level analog audio signals from source equipment such as CD players, DVD players, and MP3 players etc. The two audio channels are then available to any zone that has DIP switch 4 set to Bus B (up), and switch 3 set to Bus (up). (See DIP switches on next page.)

The loop outputs allow a copy of the Bus B analog inputs to be sent out and shared with other units. The loop outputs are directly wired internally to the Bus B analog inputs, and will pass signals to other units, even if the host unit is powered off.

The Signal Present LED lights whenever a signal is present at the Bus B input.

ARCHITECT™

Models P800

Installation Manual

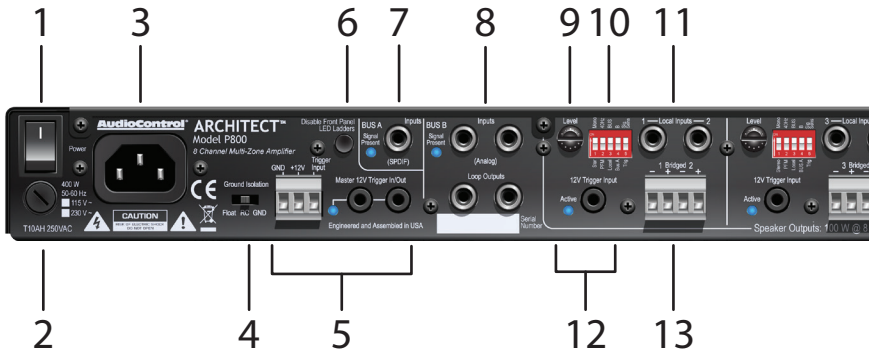

## Zone Section

(all details are the same for each zone)

- 9. **Zone Level Control** – This control sets the output level for the zone, independent of the levels of all the other zones. Turn the controls with a small flat screwdriver, or your fingers to make the adjustments. You may have to readjust the level if you change the source to that zone, from Bus A, Bus B, or Local.
- 10. **DIP Switches** – These five switches allow each zone to be set up individually:

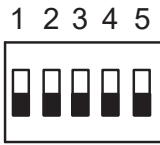

- 1 Mono
- 2 PFM 40 Hz
- 3 Local/BUS
- 4 BUS A/B
- 5 Signal Sense

**Switch 1. MONO:** Down is Stereo, Up is Mono (the inputs are summed).

**Switch 2. PFM 40 Hz** – This is a high-pass filter to reduce signal levels below 40 Hz that are not reproduced well by small speakers. Down is off, Up is on.

**Switch 3. LOCAL/BUS** – Down selects the Local input as the zone’s input, Up selects the BUS Input, either A or B, depending on the position of switch 4.

**Switch 4. BUS A/BUS B Selector** – This switch is only active when switch 3 is set to BUS (Up). Down selects BUS A (S/PDIF) as the zone’s input, Up selects BUS B (Analog).



**Switch 5. Signal Sense** – This switch controls whether the zone is always active when the master 12V trigger is active, or if the zone stays in standby until a signal is sensed. If signal sense is on (switch Up) the zone will stay in standby until an audio signal greater than 5 mV is detected. The zone will remain active whenever a signal is present. After two minutes with no signal detected, the zone will return to standby.

**11. Local Inputs** – These are line-level analog RCA stereo inputs. These local inputs may be selected to play in this zone by setting DIP switch 3 Down.

Local Inputs may not be bussed to other zones. For Matrix bussing capability (and a plethora of other really cool features) please see our Director Matrix models.



## DIP Switch Function Table

| Switch | Label        | Down (OFF)  | Up (ON)  |
|--------|--------------|--|---|
| 1      | Mono         | The zone is Stereo   | The zone is Mono  |
| 2      | PFM 40 Hz    | The 40 Hz high pass filter is off  | The 40 Hz high pass filter is on  |
| 3      | Local/BUS    | The zone is using the Local input  | The zone is using the BUS input selected by switch 4                                      |
| 4      | BUS A/B      | The zone is using the BUS A input (S/PDIF, if switch 3 is set to BUS                         | The zone is using the BUS B input (Analog), if switch 3 is set to BUS                     |
| 5      | Signal Sense | Signal sense is off  | Signal sense is on  |

- 11. 12V Local Trigger** – This TS 1/8" connector allows each zone to be individually turned on or put into standby.

The local 12V trigger takes priority over the signal sense circuit. Whenever a plug is inserted into the 12V trigger input jack, signal sense is disabled in that zone.



**Note:** The local 12V trigger cannot activate a zone unless the master trigger is also activated or jumpered on.

**Pinout:**

Tip = Input  
Sleeve = Ground

**Using a contact closure:**

An open connection will set the zone to active.

Shorting the tip to the sleeve will set the zone to standby.

**Using a 12V trigger source:**

Connect the source ground to the sleeve.

Connect the source output to the tip.

A voltage of +3V to +12V will set the zone to active; 0V will set the zone to standby.

**Zone Active LED** – This LED will turn blue whenever the zone is active. The LED will be off whenever the zone is in standby.

ARCHITECT™

Models P800

Installation Manual

**13. Speaker Outputs** – This 4-pin connector allows easy connection of two speakers for stereo operation, or one speaker for bridged mono operation.

**Stereo Speaker Connection:**  
Set the zone's Dip switch 1 Down (stereo). Note the polarity markings on the output connector.

 The speaker impedance should be 4 Ohms minimum in stereo operation.

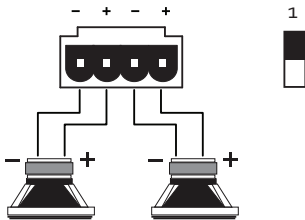

## Speaker Connections

Establish a standard connection color code and stick with it. One conductor of the speaker wire is normally marked by a different color (silver versus copper) or there is a ribbing on one side. Typically this marked conductor is used for the positive (+) speaker leads. Really good wire has Positive and Negative printed right onto the wire jacket.

Match the polarity markings on the unit with the polarity markings on your speakers.

See the next page for some handy information about speaker and wiring impedance.

**Bridged Mono Speaker Connection:**  
Set the zone's Dip switch 1 Up (mono). Note the polarity markings on the output connector. In this mode, the input signals are combined in mono, and the power from both channels is combined to drive a single speaker.

 The speaker impedance should be 8 Ohms minimum in bridged mono operation.

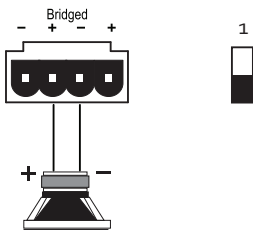

To run two speakers in dual-mono, connect them in the same way as shown in the **Stereo** speaker diagram above.

## Speaker and Wiring Impedance

Speaker impedance often is and should be straight forward. Speakers, like other resistors, if wired in parallel “show” lower values than the individual components. Here are two examples for calculating speakers wired in parallel:

### Calculating Impedance

For three 8 Ohm speakers wired in parallel (pluses connected to pluses) the impedance is  $1/8 + 1/8 + 1/8 = 3/8$   
Then take the inverse or  $8/3 = 2.66 \Omega$

For two 8 Ohm speakers wired in parallel (pluses connected to pluses) the impedance is  $1/8 + 1/8 = 2/8$   
Then take the inverse or  $8/2 = 4 \Omega$

Often the real world is more complicated than theory, and for speakers this is the case. An 8 Ohm speaker is not 8 Ohms at all frequencies. Plus passive crossover networks add their own changing conditions.

Be aware of speakers that have significant dips from “nominal” values in portions of their frequency range, and speakers that are rated at unusual impedances, for example 3.5 Ohms. The Architect model is tolerant of lower impedance loads, however, all good designs use some margin of error.

Your choice of speaker wire gauge and the length of the runs, also affects the speaker impedance load presented to the amplifiers. As you can see in this table, even fairly short speaker runs can have significant resistance if you use a smaller wire gauge. This can be a benefit if you are paralleling lots of speakers. The wire itself acts as an impedance limiter, since the amplifier cannot see a speaker load lower than the resistance of the wire. The downside of this wire resistance is that you waste some part of the total power available to the speakers.

### Speaker Wire Resistance:

#### Wire Gauge versus Run Length

| Wire Gauge | Run Length |       |       |       |       |
|------------|------------|-------|-------|-------|-------|
|            | 25'        | 50'   | 100'  | 250'  | 500'  |
| 24 GA      | 1.3Ω       | 2.6Ω  | 5.1Ω  | 12.8Ω | 25.7Ω |
| 22 GA      | 0.8Ω       | 1.6Ω  | 3.24Ω | 8.1Ω  | 16.0Ω |
| 20 GA      | 0.5Ω       | 1.0Ω  | 2.0Ω  | 5.0Ω  | 10.1Ω |
| 18 GA      | 0.3Ω       | 0.6Ω  | 1.28Ω | 3.2Ω  | 6.4Ω  |
| 16 GA      | 0.2Ω       | 0.4Ω  | 0.8Ω  | 2.0Ω  | 4.0Ω  |
| 14 GA      | 0.1Ω       | 0.25Ω | 0.5Ω  | 1.26Ω | 2.5Ω  |
| 12 GA      | 0.08Ω      | 0.16Ω | 0.32Ω | 0.8Ω  | 1.6Ω  |

ARCHITECT™

Models P800

Installation Manual

# Troubleshooting

Many problems can be eliminated by re-checking the wiring and settings of the unit. If a problem cannot be solved using the guide below, please call the AudioControl team for further assistance, or e-mail us at [sound.great@audiocontrol.com](mailto:sound.great@audiocontrol.com)

## 1. No Sound

- a. Verify the Power LED is Blue.
- b. Verify Protection LED is Off.
- c. Verify Zone Status LED is Blue.
- d. If you are not using master triggering, check that there is a wire link between the +12V pin and the Trigger Input pin of the Master Trigger 3-pin connector block.

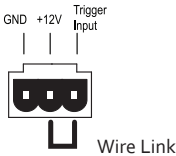

- e. Verify the source unit is operating.
- f. Check the speaker connector plugs on the rear panel.
- g. Unplug the power cord and check the AC Power Fuse on the rear panel.

## 2. Protection LED is off, but none of the Zone Status LEDs are on:

- a. Defeat the signal-sense circuits using the zone DIP switches on the rear panel. All of the zone status LEDs should turn on. If not, call AudioControl's customer service.
- b. Verify the source unit is operating.
- c. Increase the preamp volume if signal sense is engaged, or just going steady.
- d. Adjust the rear panel zone gain controls clockwise.

## 3. Channel Status LED is Red:

- a. Check speaker leads for a short. Swap speaker connectors on rear to see if the problem moves with the wires.
- b. If the unit is excessively hot, turn down the volume and allow it to cool off. The protection LED should turn off after a short while. Verify that any ventilation holes have not become blocked.
- c. The speaker impedance may be too low. Use an Ohmmeter to measure the impedance on the speaker wires.

## 4. Speaker channels are cutting in and out:

- a. If using external volume controls, check that they can handle the power output.
- b. Make sure the speaker impedance is not less than 4 Ohms, or 8 Ohms when used in bridged mono.
- c. There may be a short in the wires. Suspect a short if the problem happens only at the highest volumes.

## 5. Protection LED is Red:

- a. Disconnect power from the unit for 3 to 4 minutes and reconnect to power.
- b. Disconnect all speaker wires. If it still turns red, and the unit has cooled, something rather serious has happened inside the unit. Call AudioControl's lonely folks in customer service.

---

**6. Speaker Buzzing or Crackling at high volume:**

- a. Reduce any preamplifier/equalizer low-frequency boost.
- b. Turn off your chainsaw and bacon-frying "Sounds of the Pacific Northwest" CD.

**7. There is no audio input signal, but the Zone Status LEDs are still blue:**

- a. Check the signal-sense switches on the rear panel. If they are not engaged, the zone status LEDs will stay on as long as the master trigger is enabled.
- b. The zone status LEDs stays on for 2 minutes (depending on music volume) after the audio signal has stopped. This delay helps prevent prematurely muting during quiet passages or song changes.

**8. The unit is on but you cannot trigger it off**

- The unit will stay on if either the 12v master trigger is on, or jumpered on.

**9. Is an in-wall volume control rated at 100 Watts (continuous) adequate?**

- Just barely is the simple answer. Go for one with a higher rating if you want a reliable long-lasting system. Although the Architect model P800 is rated at 100 Watts, it is a conservative number, and it can put out more power if only a few channels are driven. In contrast to the conservative rating of the Architect model P800, the wall volume control may be rated using favorable assumptions. Also make sure the volume control power rating is continuous not peak. The continuous rating is about one-third of peak.

**10. The Architect model P800 looks like this:**



- a. It has been installed upside down.
- b. You are trying a new Yoga position.

---

**ARCHITECT™**

Models P800

Installation Manual

# Block Diagram

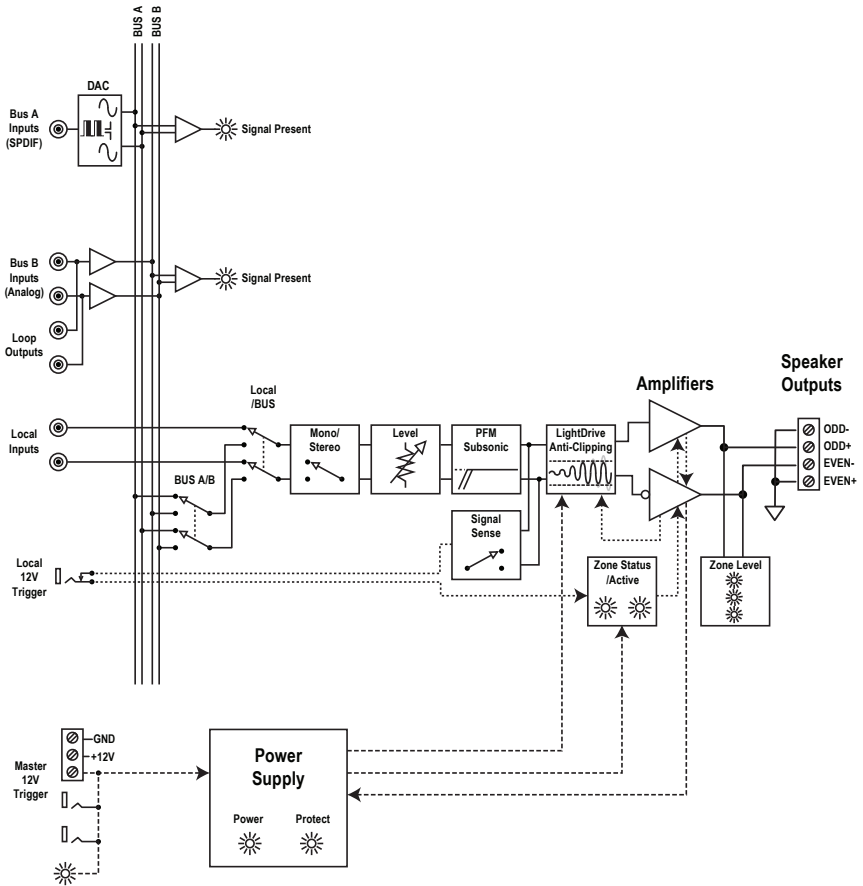

# Simplified Block Diagram

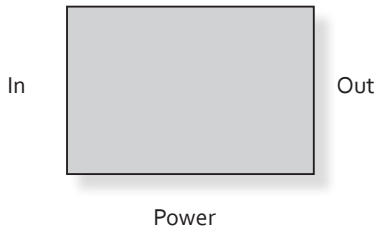

# P800 Specifications

## Output Power

|                                |   |
|--------------------------------|---|
| Per Channel .....              | 100 Watts @ 8 Ohm, 200 Watts @ 4 Ohm      |
| Bridged Mono.....              | 400Watts @ 8 Ohm                          |
| Signal to Noise Ratio .....    | > 105 (A wtd, ref full output)            |
| Crosstalk .....                | > 80 dB @ 1 kHz                           |
| Damping Factor .....           | >300                                      |
| Gain .....                     | 30 dB                                     |
| Analog Input Sensitivity ..... | 1 Vrms for full output, level at maximum  |
| DAC Specifications .....       | 32 – 192 kHz sample rate, 16/24 bit depth |

## AC Power Requirements

|   |            |
|---|------------|
| Standby.....                                | 0.8 Watts  |
| Idle (main power on, all channels off)..... | 35 Watts   |
| All channels active .....                   | 60 Watts   |
| All channels 1/8th rated power.....         | 180 Watts  |
| Full Power.....                             | 1800 Watts |

## BTU/hr Output

|   |             |
|---|-------------|
| Standby.....                                      | 2.7 BTU/hr  |
| Idle (main power on, all channels off).....       | 120 BTU/hr  |
| All channels active .....                         | 192 BTU/hr  |
| All channels 1/8th rated power.....               | 242 BTU/hr  |
| Full Power (20A residential service limited)..... | 1560 BTU/hr |

## Dimensions

|                       |            |
|-----------------------|------------|
| Height .....          | 1.75" (1U) |
| Width (ears on) ..... | 19.0"      |
| Width (ears off)..... | 17.0"      |
| Depth .....           | 15.8"      |
| Weight.....           | 15 lbs     |

*Please note: Because of AudioControl's bold and daring quest to push back the frontiers of audio perfection, all specifications are subject to change without notice, and at any time, including (and not limited to) breaktime, lunchtime, and afternoon tea on the front lawn.*

---

**ARCHITECT™**

 Models P800
 

---

Installation Manual

## What to do if you need service

First, if you need service, it is probably best to go and see a trained health care professional.

If the Architect Model P800 needs service, then please contact AudioControl, either by e-mail or phone. We will verify if there is anything wrong in the system that you can correct yourself, or if it needs to be sent back to our factory for repair.

Please include the following items when returning the unit:

1. A copy of your proof of purchase. No originals please. We cannot guarantee returning them to you.
2. A brief explanation of the trouble you are having with the unit. (You'd be surprised how many people forget this.) If you can supply a really detailed description of the problem, this would be so much better, and our service technicians may add you to their Christmas Card list. Please include any notes about the system and other components you are using. Is it an intermittent problem that only occurs on the first full moon of Spring?
3. A return street address. (No PO Boxes, please).
4. A daytime phone number in case our technicians have a question about the problem you are having, or if they are just feeling lonely.
5. Package the unit in the original packaging if you still have it, and if the cat hasn't had three litters of kittens in the box. Use great care and plenty of good packing materials to protect the unit and prevent it from moving about inside the box. Do not use loose materials like packing peanuts or real peanuts.

You are responsible for the freight charges to us, but we'll pay the return freight back as long as the unit is under warranty. We match whatever shipping method you use to send it to us, so if you return the unit overnight freight, we send it back overnight. We recommend United Parcel Service (UPS) for most shipments.

### Repair service is available at:

Attention: Service Department

22410 70th Avenue West,

Mountlake Terrace,

WA 98043 USA

Phone 425-775-8461

FAX 425-778-3166

e-mail: [sound.great@audiocontrol.com](mailto:sound.great@audiocontrol.com)



# The Warranty

In just the same way as being covered in honey and thrown into a dark pit full of hungry woodchucks, people are scared of warranties. Lots of fine print. Months of waiting around. Well, fear no more. This warranty is designed to make you rave about AudioControl. It's a warranty that looks out for you and your client, plus helps you resist the temptation to have your friend Sparky, who's "good with electronics," try to repair your AudioControl product. So go ahead, read this warranty, then register the information at [www.audiocontrol.com/product-registration](http://www.audiocontrol.com/product-registration) and include your comments.

Our warranty has conditional conditions! "Conditional" doesn't mean anything ominous. The Federal Trade Commission tells all manufacturers to use the term to indicate that certain conditions have to be met before they'll honor the warranty. If you meet all of these conditions, AudioControl will, at its discretion, repair or replace any AudioControl products that exhibit defects in materials and/or workmanship during the warranty on your product for five (5) years from the date you bought it, and we will fix or replace it, at our option, during that time.

## Here are the conditional conditions:

1. You must fully register your purchase within 15 days of the purchase date by going to the AudioControl product registration page at [www.audiocontrol.com/product-registration](http://www.audiocontrol.com/product-registration). Failure to register your product will negate the warranty.
2. You need to hold on to your sales receipt! All warranty service requires original sales receipt documentation. The warranty only applies to the original purchaser from an authorized AudioControl dealer. Note: Products purchased from unauthorized dealers are not covered under warranty.
3. If an authorized AudioControl dealer installs your AudioControl product, the warranty is five years, otherwise the warranty is limited to one year.
4. Our warranty covers AudioControl products that have been installed according to the instructions in the installation manual.
5. You cannot let anybody who isn't: (A) the AudioControl factory; or (B) somebody authorized in writing by AudioControl service your AudioControl product. If anyone other than (A), or (B) messes with your AudioControl product, the warranty is void.
6. The warranty is void if the serial number is altered, defaced or removed, or if your product has been used improperly. Now that may sound like a big loophole, but here is what we mean by this: Unwarranted abuse is: (A) physical damage (don't use your product to level your dining room table); (B) improper connections (120 volts into the RCA jacks can fry the poor thing); (C) sadistic things! This is the best product we know how to build, but for example if you mount it to the front bumper of your car, drop it over the Niagara Falls or use it for Clay Pigeon shooting practice, something will go wrong.

Assuming you conform to 1 through 6, and it really isn't all that hard to do, we get the option of fixing your product or replacing it with a new one at our discretion.

In the event that your product is out of warranty or not covered under our warranty you may request to have any damage repaired at our normal "Out of Warranty" repair cost.

---

ARCHITECT™

Models P800

Installation Manual

## Legalese Section

This is the only warranty issued by AudioControl. This warranty gives you specific legal rights, and you may also have rights that vary from state to state. Promises of how well your AudioControl product will work are not implied by this warranty. Other than what we've said we'll do in this warranty, we have no obligation, express or implied. We make no warranty of merchantability or fitness for any particular purpose. Also neither we nor anyone else who has been involved in the development or manufacture of the unit will have any liability of any incidental, consequential, special or punitive damages, including but not limited to any lost profits or damage to other parts of your system by hooking up to the unit (whether the claim is one for breach of warranty, negligence of other tort, or any other kind of claim). Some states do not allow limitations of consequential damages.

# Installation Notes

| Installation: |      |       |       |       |              |       |             |  |
|---------------|------|-------|-------|-------|--------------|-------|-------------|--|
| Installer:    |      |       |       |       |              |       |             |  |
| Zone          | Room | Local | Bus A | Bus B | Signal Sense | 40 Hz | Mono Stereo |  |
| 1             |      |       |       |       |              |       |             |  |
| 2             |      |       |       |       |              |       |             |  |
| 3             |      |       |       |       |              |       |             |  |
| 4             |      |       |       |       |              |       |             |  |
| 5             |      |       |       |       |              |       |             |  |
| 6             |      |       |       |       |              |       |             |  |
| 7             |      |       |       |       |              |       |             |  |
| 8             |      |       |       |       |              |       |             |  |
| 9             |      |       |       |       |              |       |             |  |
| 10            |      |       |       |       |              |       |             |  |
| 11            |      |       |       |       |              |       |             |  |
| 12            |      |       |       |       |              |       |             |  |
| 13            |      |       |       |       |              |       |             |  |
| 14            |      |       |       |       |              |       |             |  |
| 15            |      |       |       |       |              |       |             |  |
| 16            |      |       |       |       |              |       |             |  |
| Notes         |      |       |       |       |              |       |             |  |
|               |      |       |       |       |              |       |             |  |
|               |      |       |       |       |              |       |             |  |
|               |      |       |       |       |              |       |             |  |
|               |      |       |       |       |              |       |             |  |
|               |      |       |       |       |              |       |             |  |
|               |      |       |       |       |              |       |             |  |
|               |      |       |       |       |              |       |             |  |
|               |      |       |       |       |              |       |             |  |
|               |      |       |       |       |              |       |             |  |
|               |      |       |       |       |              |       |             |  |
|               |      |       |       |       |              |       |             |  |
|               |      |       |       |       |              |       |             |  |
|               |      |       |       |       |              |       |             |  |
|               |      |       |       |       |              |       |             |  |
|               |      |       |       |       |              |       |             |  |

# Basic Cha-Cha

