



CDPS-P311R

HDMI/VGA Video Streamer with Recording



Operation Manual

HDMI®
HIGH-DEFINITION MULTIMEDIA INTERFACE

The terms HDMI, HDMI High-Definition Multimedia Interface, and the HDMI Logo are trademarks or registered trademarks of HDMI licensing Administrator, Inc.

DISCLAIMERS

The information in this manual has been carefully checked and is believed to be accurate. Cypress Technology assumes no responsibility for any infringements of patents or other rights of third parties which may result from its use.

Cypress Technology assumes no responsibility for any inaccuracies that may be contained in this document. Cypress also makes no commitment to update or to keep current the information contained in this document.

Cypress Technology reserves the right to make improvements to this document and/or product at any time and without notice.

COPYRIGHT NOTICE

No part of this document may be reproduced, transmitted, transcribed, stored in a retrieval system, or any of its part translated into any language or computer file, in any form or by any means—electronic, mechanical, magnetic, optical, chemical, manual, or otherwise—without express written permission and consent from Cypress Technology.

© Copyright 2018 by Cypress Technology.

All Rights Reserved.

TRADEMARK ACKNOWLEDGMENTS

All products or service names mentioned in this document are trademarks of the companies with which they are associated.



SAFETY PRECAUTIONS

Please read all instructions before attempting to unpack, install or operate this equipment and before connecting the power supply. Please keep the following in mind as you unpack and install this equipment:

- Always follow basic safety precautions to reduce the risk of fire, electrical shock and injury to persons.
- To prevent fire or shock hazard, do not expose the unit to rain, moisture or install this product near water.
- Never spill liquid of any kind on or into this product.
- Never push an object of any kind into this product through any openings or empty slots in the unit, as you may damage parts inside the unit.
- Do not attach the power supply cabling to building surfaces.
- Use only the supplied power supply unit (PSU). Do not use the PSU if it is damaged.
- Do not allow anything to rest on the power cabling or allow any weight to be placed upon it or any person walk on it.
- To protect the unit from overheating, do not block any vents or openings in the unit housing that provide ventilation and allow for sufficient space for air to circulate around the unit.
- Please completely disconnect the power when the unit is not in use to avoid wasting electricity.

VERSION HISTORY

REV.	DATE	SUMMARY OF CHANGE
RDV1	2019/06/24	Preliminary release
RDV2	2020/01/14	Updated feature descriptions/screenshots
RDV3	2020/06/12	Updated Telnet command list



CONTENTS

1. Introduction	1
2. Applications	1
3. Package Contents	2
4. System Requirements	2
5. Features	3
6. Operation Controls and Functions	4
6.1 Front Panel.....	4
6.2 Rear Panel.....	6
6.3 Remote Control	7
6.4 RS-232 Pinout and Defaults	8
6.5 WebGUI Control	9
6.5.1 Live Tab	11
6.5.2 Streaming Tab	13
6.5.3 Audio Mixer Tab.....	15
6.5.4 Video Switch Tab.....	16
6.5.5 EDID Setting Tab.....	18
6.5.6 Record Setting Tab.....	20
6.5.7 Time Setting Tab.....	23
6.5.8 User Config Tab.....	25
6.5.9 System Setting Tab	25
6.6 Telnet Control	27
7. CONNECTION DIAGRAM	44
8. Specifications	45
8.1 Technical Specifications	45
8.2 Video Specifications	46
8.3 Audio Specifications	48
8.3.1 Digital Audio	48
8.3.2 Analog Audio	48
8.4 Cable Specifications	49
9. Acronyms	50



1. INTRODUCTION

This Video Streaming Recorder makes online broadcasting of live video, with a locally stored archive, an easy and simple process. Video sources from cameras, PCs, video game consoles, etc. are a breeze to connect for immediate broadcast and recording. Video content up to 4K UHD* is supported and is automatically scaled to a resolution that is more appropriate for efficient streaming. In addition to the standard HDMI input, a VGA input with a paired analog stereo audio input is also available as a source. An HDMI output is provided for local monitoring of the selected input source.

All video content is encoded and streamed with minimal latency and high quality making it ideal for live streaming events to a variety of popular online streaming services or within the local network. The video may also be recorded locally (via SD card or USB thumb drive) or to a local network drive while it is being streamed. An audio mixer function is included, allowing an external audio source to be mixed with the embedded audio of your HDMI source (LPCM 2.0 only) for your video stream.

Comprehensive EDID management provides improved compatibility with different sink devices. The intuitive WebGUI provides easy control of your live event stream including source selection, resolution, bitrate and more. Audio functions include volume level adjustment, mute, and mixer source selection. This unit can be controlled and configured via front panel buttons, an intuitive WebGUI, RS-232, or Telnet.

2. APPLICATIONS

- Webcasting
- Social Media Broadcasting
- Live Event Streaming
- Video on Demand Streaming
- Live recording and storage

3. PACKAGE CONTENTS

- 1× HDMI/VGA Video Streamer with Recording
- 1× 5V/2.6A DC Power Adapter
- 1× Remote Control (CR-187)
- 1× Operation Manual

4. SYSTEM REQUIREMENTS

- HDMI or VGA source equipment such as a media player, video game console, PC, or video camera.
- Available streaming server destination such as YouTube or Facebook or a recording storage target such as an SD Card or USB thumb drive.
- HDMI receiving equipment such as an HDTV, monitor or audio amplifier.
- The use of Premium High Speed HDMI cables is highly recommended.
- Video streaming preview support within the WebGUI requires the use of the Chrome, Internet Explorer or Safari browser with the appropriate plugins (VLC for IE and Safari or VXG Player for Chrome) installed.

Note: The Firefox browser does not currently support the WebGUI's video streaming preview window.

- To view RTSP streams directly on the local network, RTSP stream compatible video player software (such as VLC Media Player or PotPlayer) must be used.

5. FEATURES

- 1 HDMI input and 1 VGA input
- 1 HDMI output (for local source monitoring)
- HDCP 1.x and HDCP 2.2 compliant

Note: HDCP encrypted sources cannot be streamed over the Internet or recorded and will be blacked out

- HDMI input/output supports resolutions up to 4K UHD (18Gbps, 4K@60Hz 4:4:4, 8-bit)
- VGA input supports resolutions up to 1920×1080@60Hz
- Advanced H.264 video streaming and recording is provided at QVGA (320×240), VGA (640×480), 720p, or 1080p at up to 60fps
- Recorded video can be stored on a locally inserted SD card, USB thumb drive, or to a designated network drive
- Can act as a streaming server (using RTP/RTSP protocols) or streaming client (using the RTMP protocol)
- Audio embedding and mixing support with the analog stereo audio input

Note: Analog audio can only be mixed with LPCM 2.0 audio from the HDMI source

- Supports scheduled recording with an internet updated calendar
- Supports text overlays over live broadcasts including a countdown timer
- Integrated downscaling function will convert UHD video content (up to 4K@60Hz) down to 1080p or lower for live video broadcast and recording
- Generates 4 simultaneous streams from the same video source (1080p@60fps, 1080p@30fps, VGA@30fps, QVGA@30fps) for easy system integration at multiple bandwidth targets
- Supports automatic input switching
- Advanced EDID management including Internal, External & User configured EDID selections
- Control via front panel buttons, WebGUI, Telnet, RS-232, and IR

6. OPERATION CONTROLS AND FUNCTIONS

6.1 Front Panel

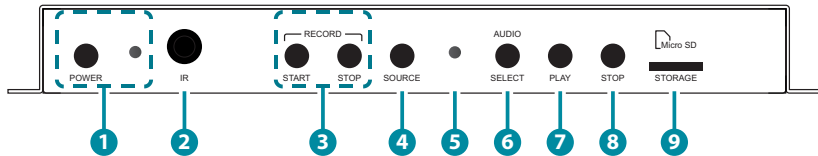

- 1 POWER Button & LED:** This LED will illuminate green to indicate the unit is on and receiving power. When the unit is in stand-by mode the LED will illuminate red.

Note: The Power LED will blink while video recording is active.
- 2 IR Window:** Accepts IR signals from the included IR remote for control of this unit only.
- 3 RECORD START Button:** Press this button to immediately start recording to the designated recording target.

RECORD STOP Button: Press this button to immediately stop any current recording session.
- 4 SOURCE Button:** Press this button to toggle between the HDMI and VGA inputs. The status LED will change depending on the input selection.

Note: Changing the input source will cause the video stream to restart. Connected stream targets may need to be restarted or reconnected.
- 5 Status LED:** This multi-function LED indicates the current video source selection, audio mixer state and RTMP streaming client status.

LED State	Description
● RED	Video source is VGA
● BLUE	Video source is HDMI
● PURPLE	Video source is HDMI, Audio Mixer is enabled
Solid (any color)	RTMP streaming client is inactive
Blinking (any color)	RTMP streaming client is active

- 6 AUDIO SELECT Button:** Press this button to enable/disable the Audio Mixer function. The mixer's settings are configured within the WebGUI.
- 7 PLAY Button:** Press this button to start streaming to the configured target server. The Status LED will blink to indicate the stream is currently active.

Note: The target streaming service controlled by this button is defined in the WebGUI.

- 8 STOP Button:** Press this button to stop streaming to the configured target server. The Status LED will be lit solidly to indicate the stream is stopped.
- 9 Micro SD STORAGE Slot:** Insert a standard Micro SD card for storage of recorded video. (Optional)

*Note: SD/SDHC/SDXC/SDUC memory cards are supported. Storage media must be formatted as FAT32 or exFAT. Video files are stored in *.mp4 format.*

6.2 Rear Panel

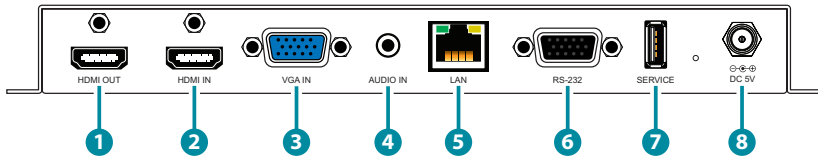

- 1 HDMI OUT Port:** Connect to an HDMI TV, monitor or amplifier for digital video and audio output.
- 2 HDMI IN Port:** Connect to HDMI source equipment such as a media player, game console or set-top box.
Note: HDCP encrypted sources cannot be streamed over the Internet or recorded and will be blacked out.
- 3 VGA IN Port:** Connect to VGA source equipment such as a PC or laptop.
- 4 AUDIO IN Port:** Connect to the stereo analog output of a device such as a CD player or PC.
Note: By default, audio from this port is embedded with the VGA video source.
- 5 LAN Port:** Connect to a network switch or router for transmission and distribution of streamed video as well as to control the unit via Telnet or WebGUI.
Note: The maximum number of simultaneous stream connections is limited by available network bandwidth and the unit's CPU load.
- 6 RS-232 Port:** Connect directly to a PC, laptop or other serial control device to send RS-232 commands to control the unit.
- 7 SERVICE Port:** Attach a standard USB thumb drive or external hard drive for storage of recorded video. (Optional)
*Note: Storage media must be formatted as FAT32 or exFAT. Video files are stored in *.mp4 format.*
- 8 DC 5V Port:** Plug the 5V DC power adapter into this port and connect it to an AC wall outlet for power.

6.3 Remote Control

- 1 **POWER Button:** Press to power the unit on or place it into stand-by mode.
- 2 **COUNTDOWN Button:** Press to enable/disable the Countdown Timer display on the HDMI and streaming output.
- 3 **PLAY/STOP Buttons:** Press to start/stop streaming to the configured target server.
- 4 **TEXT SCREEN Button:** Press to enable/disable the “Text Screen” feature.
- 5 **HDMI/VGA Buttons:** Press to select HDMI or VGA as the input source.

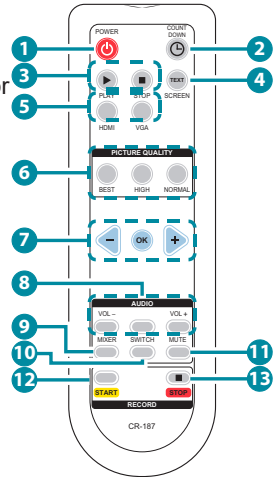

- 6 **PICTURE QUALITY (BEST/HIGH/NORMAL) Buttons:** Press these buttons change the streaming bitrate and resolution of the streaming output. Available options are:
 - Best** (1080p@30fps, 3000Kbps)
 - High** (720p@30fps, 2000Kbps)
 - Normal** (VGA@15fps, 1500Kbps)

Note: Changing the bitrate will force the video stream to restart.
- 7 **- (MINUS)/OK/+ (PLUS) Buttons:** Press the OK button to start or stop the Countdown Timer. Press the plus and minus buttons to increase or decrease the remaining time in 30 second steps.
- 8 **VOL - /VOL+ Buttons:** Press to increase or decrease the mixer output volume.
- 9 **MIXER Button:** Press to enable/disable the Audio Mixer function.
- 10 **SWITCH Button:** Press to toggle the audio source for the HDMI input between HDMI and analog stereo when the mixer is not enabled.
- 11 **MUTE Button:** Press to mute/unmute all audio output.
- 12 **RECORD START Button:** Press to start recording video to the currently designated storage location.
- 13 **RECORD STOP Button:** Press to stop recording video.

6.4 RS-232 Pinout and Defaults

Serial Port Default Settings	
Baud Rate	19200
Data Bits	8
Parity Bits	None
Stop Bits	1
Flow Control	None

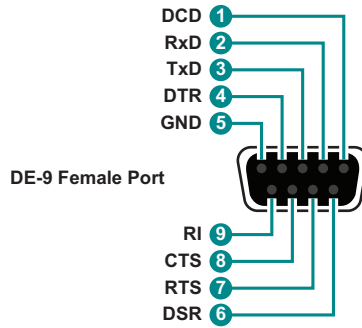

6.5 WebGUI Control

• Device Discovery

Please obtain the “Device Discovery” software from your authorized dealer and save it in a directory where you can easily find it.

Connect the unit and your PC/Laptop to the same active network and execute the “Device Discovery” software. Click on “Find Devices on Network” and a list of devices connected to the local network will show up indicating their current IP address.

Note: The unit’s default IP address is 192.168.1.50.



Product Name	Description	IP Address	MAC Address

By clicking on one of the listed devices you will be presented with the network details of that particular device.

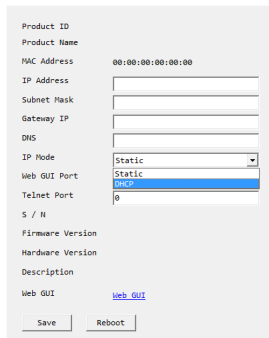

Product ID
Product Name
MAC Address 00:00:00:00:00:00
IP Address
Subnet Mask
Gateway IP
DNS
IP Mode Static
Web GUI Port Static
Telnet Port 0
S / N
Firmware Version
Hardware Version
Description
Web GUI [Web GUI](#)
Save Reboot

- 1) IP Mode:** If you choose, you can alter the static IP network settings for the device, or switch the unit into DHCP mode to automatically obtain proper network settings from a local DHCP server. To switch to DHCP mode, please select DHCP from the IP mode drop-down, then click “Save” followed by “Reboot”.
- 2) WebGUI Hotkey:** Once you are satisfied with the network settings, you may use them to connect via Telnet or WebGUI. The network information window provides a convenient link to launch the WebGUI directly.

• WebGUI Overview

After connecting to the WebGUI's address in a web browser, the login screen will appear. Please enter the appropriate user name and password then click "Submit" to log in.

Note: The default user name and password is "admin".

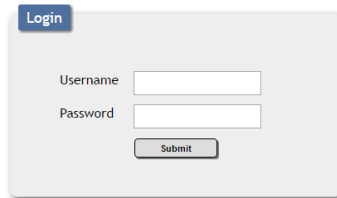

A login form with a blue "Login" button at the top left. Below it are two input fields: "Username" and "Password". At the bottom center is a "Submit" button.

On the left side of the browser you will see the following menu tabs where all primary functions of the unit are controllable via the built in WebGUI. The individual functions will be introduced in the following sections.

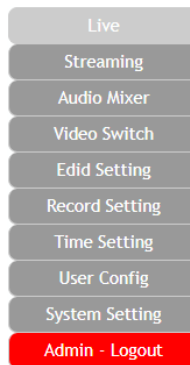

Clicking the red "Logout" tab will automatically log the currently connected user out of the WebGUI and return to login page.

6.5.1 Live Tab

This tab provides viewing access to the first local video stream channel (of 4 channels total) generated by the unit. The video source can be selected here and the stream resolution, framerate and bitrate is also displayed. At the bottom of the page, a connection address for local video stream channel 1 is displayed in the format: “rtsp://xxx.xxx.xxx.xxx/live/ch1/h264_aac” (xxx.xxx.xxx.xxx = the unit’s current IP address). When 3rd party video player software with RTSP streaming support is used to view streams from this unit, this is the URL that should be used to connect. To view streaming channels 2~4, change “ch1” in the address to “ch2”, “ch3”, or “ch4”, as appropriate.

Note: The Channel 1 configuration is set on the “Record Setting” tab. Channels 2~4 contain the same video content presented at different streaming resolutions. Channel 2 matches the current settings from the “Streaming” tab, Channel 3 is 640x480@30fps, and Channel 4 is 320x240@30fps.

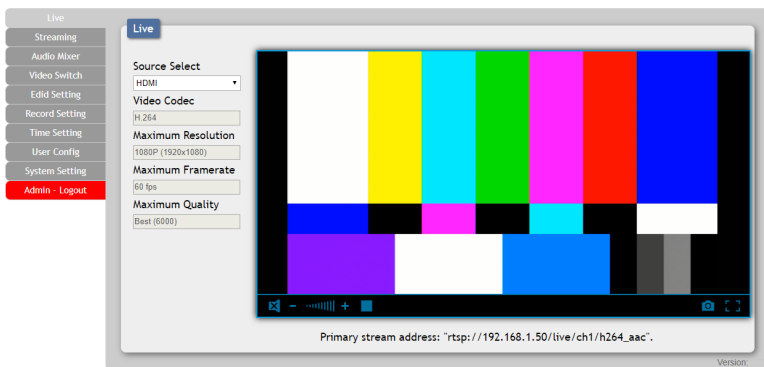

- 1) **Source Select:** Select the video input (HDMI or VGA) to stream.
Note: Changing the input here will change it globally across the unit.
- 2) **Video Codec:** Indicates the video codec used for the video stream.
Note: Currently, only H.264 is supported.
- 3) **Maximum Resolution:** Displays the current maximum resolution for streaming channel 1.
- 4) **Maximum Framerate:** Displays the current maximum framerate for streaming channel 1.

- 5) **Maximum Quality:** Displays the current maximum bitrate for streaming channel 1.
- 6) **Video Window:** This video window displays the content of streaming channel 1 and provides the details of a direct connection address that can be used to connect to this stream using 3rd party video player software such as VLC or PotPlayer.

Note: Video streaming preview support within the WebGUI requires the use of the Chrome, Internet Explorer or Safari browser with the appropriate plugins (VLC for IE and Safari or VXG Player for Chrome) installed.

6.5.2 Streaming Tab

This tab provides access to the settings and controls for the streaming channel which is used when streaming directly to a streaming service such as YouTube or Facebook. Channel 1 (Main Stream) or channel 2 (Second Stream) may be selected for broadcast. A live preview of the current video stream is also displayed on this page. Pressing the “Play” button will make the unit start streaming to the designated target server immediately and change the label of the button to read “Stop”. To stop streaming, press the “Stop” button.

Note: A stream can only be broadcast to a single dedicated service at a time. However, all 4 streaming channels are always available to be viewed directly by connecting to the unit using 3rd party video player software such as VLC or PotPlayer.

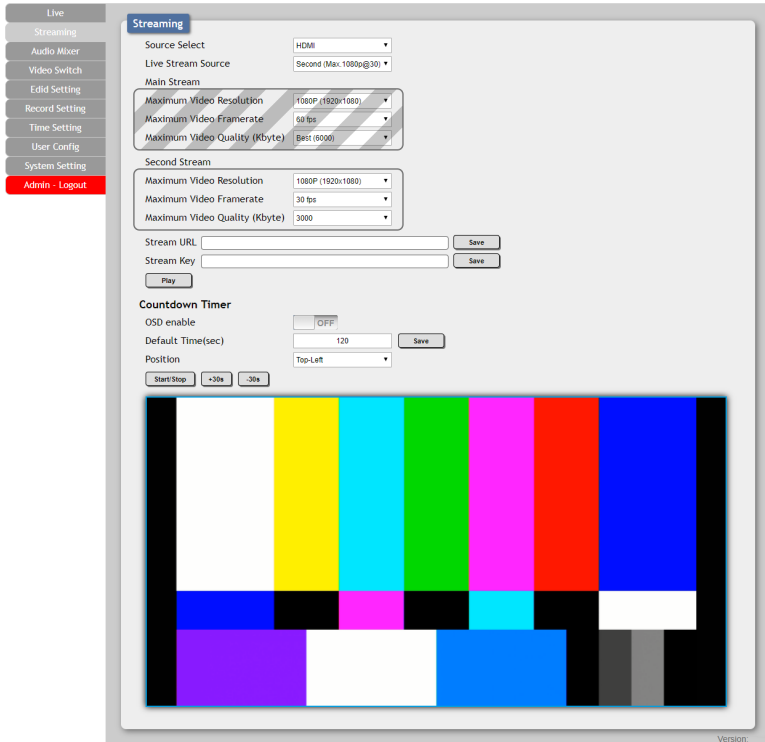

The screenshot shows the 'Streaming' configuration page. On the left is a sidebar menu with options: Live, Streaming, Audio Mixer, Video Switch, Edid Setting, Record Setting, Time Setting, User Config, System Setting, and Admin - Logout. The main content area is titled 'Streaming' and contains the following settings:

- Source Select:** HDMI
- Live Stream Source:** Second (Max:1080p@30)
- Main Stream:**
 - Maximum Video Resolution: 1080P (1920x1080)
 - Maximum Video Framerate: 60 fps
 - Maximum Video Quality (Kbyte): Best (6000)
- Second Stream:**
 - Maximum Video Resolution: 1080P (1920x1080)
 - Maximum Video Framerate: 30 fps
 - Maximum Video Quality (Kbyte): 3000
- Stream URL:** [Text input field] [Save]
- Stream Key:** [Text input field] [Save]
- Play:** [Button]
- Countdown Timer:**
 - OSD enable: OFF
 - Default Time(sec): 120 [Save]
 - Position: Top-Left
 - Buttons: Start/Stop, +30s, -30s
- Preview:** A video preview window showing a test pattern with various colored bars.
- Version:** [Small text at the bottom right]

- 1) **Source Select:** Select the video input (HDMI or VGA) to stream.
Note: Changing the input here will change it globally across the unit.
- 2) **Live Stream Source:** Use the dropdown to select which stream to broadcast when “Play” is pressed.
Note: Selecting the Main Stream allows very high bitrates (up to 6Mbps) and is not recommended unless you are sure the available internet upstream bandwidth is large enough to handle it. Adjusting the settings for the Main Stream will also affect the settings of locally recorded video.
- 3) **Maximum Video Resolution:** Select the maximum resolution to use for the currently selected streaming channel. Available resolutions are: 1080p(1920x1080), 720p(1280x720), VGA(640x480), or QVGA(320x240).
Note: The streaming resolution will not exceed the original source’s resolution even if a higher maximum is selected.
- 4) **Maximum Video Framerate:** Select the framerate to use for the currently selected streaming channel.
Note: The Second Stream has a maximum framerate of 30fps while the Main Stream can go up to 60fps.
- 5) **Maximum Video Quality:** Select the target bitrate for streaming channel 2. Available bitrates are: 6000Kbps, 3000Kbps, 2000Kbps, or 1500Kbps.
Note: 6000Kbps is only available when the Main Stream is selected.
- 6) **Stream URL:** Please enter the Stream URL provided by the specified streaming service. This is the address of the specific target streaming server. Type the Stream URL EXACTLY as provided by the streaming service. The URL will start with “rtmp://” or “rtmps://” followed by the specific destination information of the server. Click on “Save” to confirm and store the Stream URL.
- 7) **Stream Key:** Please enter the Stream Key provided by the specified streaming service. This is an encrypted key that provides the streaming server with your unique login and identification credentials. Type the Stream Key EXACTLY as provided by the streaming service. A typical stream key is a very long string of letters, numbers and symbols. Click on “Save” to confirm and store the Stream Key.

8) Countdown Timer

- **OSD Enable:** Enable or disable visibility of the on screen countdown timer.
- **Default Time(sec):** Set the starting time, in seconds, for the on screen countdown timer.
- **Position:** Use the dropdown to select the position of the on screen countdown timer.
- **Start/Stop:** Click this button to start or stop the countdown timer.
- **+30s/-30s:** Click the “+30s” button to add 30 seconds to the currently displayed countdown timer’s time. Click the “-30s” button to subtract 30 seconds.

6.5.3 Audio Mixer Tab

This tab allows for control over the Audio Mixer function of this unit. The Audio Mixer feature, when enabled, mixes the analog audio and HDMI audio inputs together with independently controllable volume levels.

Note: Only LPCM 2.0 audio from the HDMI source is supported by the mixer.

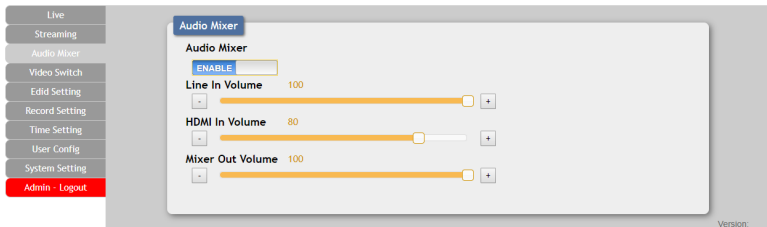

- 1) **Audio Mixer:** Enable or Disable the Audio Mixer function.
- 2) **Line In Volume:** Adjusts the volume of the analog audio source from 0% to 100%.
- 3) **HDMI In Volume:** Adjusts the volume of the HDMI audio source from 0% to 100%.
- 4) **Mixer Out Volume:** Adjusts the volume of the mixed audio output from 0% to 100%.

6.5.4 Video Switch Tab

This tab provides video/audio routing control as well as control over HDCP behavior, Input and Output names, Text Screen intermission details, and the Countdown Timer.

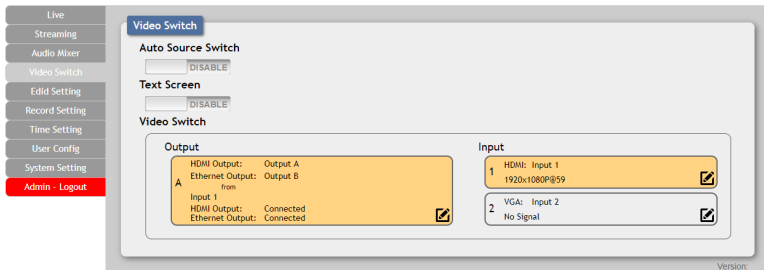

- 1) **Auto Source Switch:** Enable or disable the automatic input switching feature of this unit. When enabled, the unit will automatically switch to the most recently connected/detected input. If the current input's signal is lost, the unit will automatically switch to the other input.
- 2) **Text Screen:** The Text Screen intermission output can be used when the user wants to stream a simple text screen to indicate that there is not currently any live video to view. It may be enabled or disabled here.
Note: Enabling or disabling this feature may disconnect any currently connected streaming clients.
- 3) **Video Switch:** To assign a new video route, please click the Output button and then click on the button of the preferred Input port to route. As you select each button they will change their color to orange. The new route will become active immediately and the routing information displayed on the buttons will change accordingly.
 - **Output:** Click on this button to begin routing selection as detailed above. Click the Edit icon (✎) to open the Output Edit window and modify additional Output settings.
 - **Input:** Rename either Input or modify the HDCP behavior (Input 1 only) by clicking on the Edit icon (✎) to open the editing window. Click on "Save" to confirm and activate any changes made to a name. Changes made to the HDCP behavior are applied immediately. Available HDCP settings are:

- **HDCP Support Off:** Completely disables HDCP support on the input.
- **Refer to Source:** HDCP support follows the HDCP mode required by the connected source device.
- **Refer to Display:** HDCP support follows the HDCP mode supported by the connected sink.

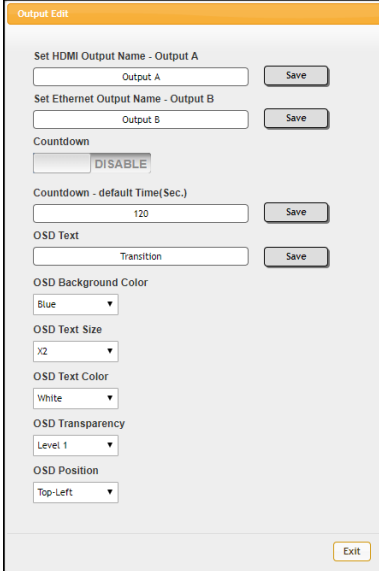

Output Edit

Set HDMI Output Name - Output A
Output A Save

Set Ethernet Output Name - Output B
Output B Save

Countdown
DISABLE

Countdown - default Time(Sec.)
120 Save

OSD Text
Transition Save

OSD Background Color
Blue

OSD Text Size
X2

OSD Text Color
White

OSD Transparency
Level 1

OSD Position
Top-Left

Exit

- 4) **Output Edit:** This window is opened after clicking on the Edit icon (✎) within the Output button and provides options to rename the Outputs, and configure the countdown timer and its associated OSD. Click on “Save” to confirm and activate any changes made to a name or to the countdown timer’s default time. All other changes are immediate.

6.5.5 EDID Setting Tab

This tab provides the option of six standard EDIDs, one sink sourced EDID and four customer uploaded EDIDs that can be assigned to the HDMI input port. The names of the four customer uploaded EDIDs can be changed if desired.

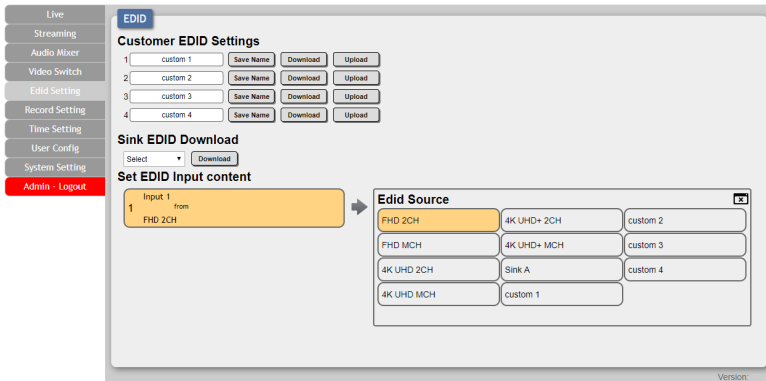

1) Customer EDID Settings

- **Save Name:** To change the name of a custom EDID, type the new name in the space provided, then click on the “Save Name” button.
- **Download:** To save an existing custom EDID to your local PC please press the “Download” button next to the EDID you would like to save. Depending on your browser settings you will either be asked where to save the downloaded file, or the file will be transferred to the default download location on your PC.
- **Upload:** To upload a custom EDID, please click the “Upload” button next to the Customer EDID Settings item you would like to change. An EDID Upload window will appear, allowing you to locate and upload the preferred EDID file (*.bin format) from a local PC. Once the correct file has been selected, please click the “Upload” button in the window, and the file will be transferred to the unit.

- 2) **Sink EDID Download:** To save the EDID from the connected HDMI display to your local PC, select the sink from the dropdown list then press the “Download” button. Depending on your browser settings you will either be asked where to save the downloaded file, or the file will be transferred to the default download location on your PC.

- 3) **Set EDID Input Content:** Click on the input button to open the EDID Source management window. Select the new EDID source to use, from the choices on the right, and the change will occur immediately.

Note: In most cases, assigning a new EDID to an input will cause the affected input to briefly blink out while the source adapts to the new information.

This unit provides the following 6 default EDIDs:

Unit's Default EDIDs	
FHD/2CH	1920×1080p@60Hz (4.95Gbps) & 8-bit color, LPCM 2.0
FHD/MCH	1920×1080p@60Hz (4.95Gbps) & 8-bit color, LPCM 7.1 & Bitstream
UHD/2CH	3840×2160p@30Hz (10.2Gbps) & Deep Color (8/10/12-bit), LPCM 2.0
UHD/MCH	3840×2160p@30Hz (10.2Gbps) & Deep Color (8/10/12-bit), LPCM 7.1 & Bitstream
UHD*/2CH	3840×2160p@60Hz (18Gbps) & Deep Color (8/10/12-bit), LPCM 2.0
UHD*/MCH	3840×2160p@60Hz (18Gbps) & Deep Color (8/10/12-bit), LPCM 7.1 & Bitstream

Note: In some rare cases it is possible for custom or external EDIDs to cause compatibility issues with certain sources. If this happens, it is recommended to switch to one of the 6 default EDIDs for maximum compatibility.

6.5.6 Record Setting Tab

This tab provides access to the settings and controls for configuring the channel 1 stream (the same stream viewed on the “Live” tab) and making a recording of it to a local or network storage location. When recording is enabled, the channel 1 video stream is saved as a *.mp4 file, encoded with the H.264 codec, to one of four possible target destinations: USB storage, Micro-SD card, network storage using NFS, or network storage using CIFS. The file will be placed within an automatically named folder structure based on the current date and time of the recording to facilitate easy sorting and file management. It is also possible to set up automatic daily recording times based on a repeating weekly schedule structure.

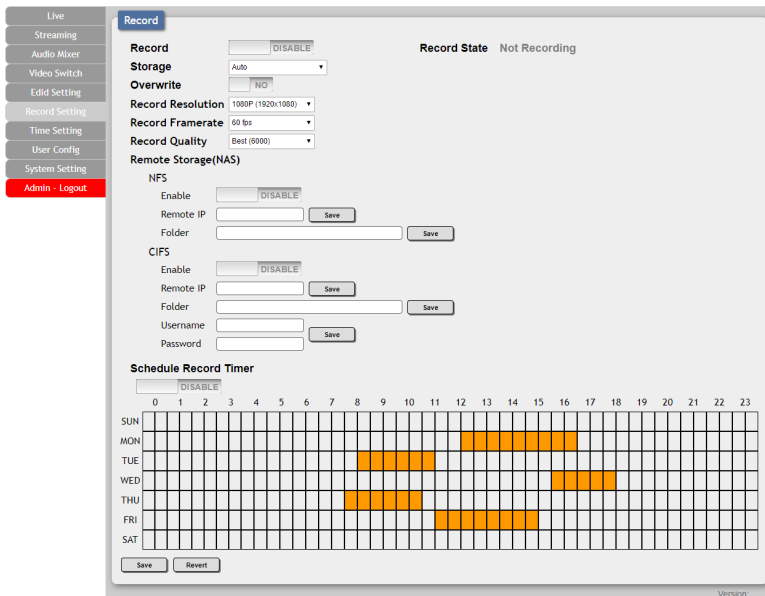

- 1) **Record:** Enable or disable recording the channel 1 video stream. When enabled, recording will begin immediately to the selected storage location.
Note: HDCP encrypted sources cannot be recorded.
- 2) **Record State:** Displays the current recording state of the unit.
- 3) **Storage:** Use the drop-down to select the storage target to use when recording. Available choices are: Auto, USB (USB storage), SDCard (Micro-SD Card), NFS (NFS based network storage), and CIFS (CIFS

based network storage). Selecting “Auto” will use the first available valid storage location using the following priority order: NFS > CIFS > USB > SDCard

- 4) **Overwrite:** Enables or disables the file overwrite function. When enabled, the unit will automatically delete older recordings, when space runs out on the selected storage location, to make room for new recordings.
- 5) **Record Resolution:** Select the maximum resolution to use for streaming channel 1. Available resolutions are: 1080p(1920x1080), 720p(1280x720), VGA(640x480), or QVGA(320x240).

Note: The recording resolution will not exceed the original source’s resolution even if a higher maximum is selected.

- 6) **Record Framerate:** Select the framerate to use for streaming channel 1. Available framerates are: 25, 30, 50, or 60 frames per second.
- 7) **Record Quality:** Select the target bitrate for streaming channel 1. Available bitrates are: Best (6000Kbps), High (3000Kbps), or Normal (2000Kbps).

- 8) **Remote Storage (NAS) NFS:** This section provides a way to configure access to a NAS (Network Attached Storage) device using the NFS protocol.

- **Enable:** Enable or disable access to the defined NFS based network storage server.
- **Remote IP:** Enter the IP address of the target NFS based NAS device. After entering the information, press the “Save” button.
- **Folder:** Enter a valid share name on the target server. The share name cannot contain spaces or special characters. This is where the recording folder structure and video files will be created. After entering the information, press the “Save” button.

Note: The target folder on the NFS server must, at a minimum, provide anonymous read, write and delete permissions.

- 9) **Remote Storage (NAS) CIFS:** This section provides a way to configure access to a NAS (Network Attached Storage) device using the CIFS protocol.

- **Enable:** Enable or disable access to the defined CIFS based network storage server.
- **Remote IP:** Enter the IP address of the target CIFS based NAS device. After entering the information, press the “Save” button.

- **Folder:** Enter a valid share name on the target server. The share name cannot contain spaces or special characters. This is where the recording folder structure and video files will be created. After entering the information, press the “Save” button.

Note: The target folder on the CIFS server must, at a minimum, provide read, write and delete permissions for the designated user.

- **Username/Password:** Enter the user name and password required for access to the specified server. After entering both items, press the “Save” button.

10) Schedule Record Timer: Enable or disable the scheduled time recording function. Each hour of each day is divided into two half-hour blocks. Currently selected recording times are indicated by orange blocks. Gray blocks indicate that no recording is currently scheduled. Blocks may be activated or deactivated by clicking on them. To easily select multiple blocks, you may click and drag across the preferred range. After setting the preferred recording blocks, press the “Save” button. To undo changes and return to the previous schedule configuration, press the “Revert” button.

6.5.7 Time Setting Tab

The Time Settings tab provides a way to set the system's time, date, and time zone. The system time can be set manually, or automatically using a defined SNTP server. If your country uses DST (Daylight Saving Time) you can enable or disable it here and configure the start and end times/dates so that your scheduled events will always occur at the correct times throughout the year.

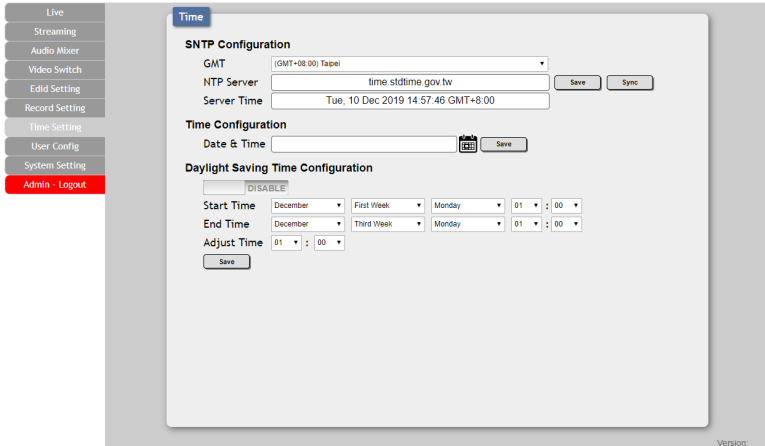

1) SNTP Configuration

- **GMT:** Select the preferred time zone from the options in the dropdown.
- **NTP Server:** Enter the address of the network time server to use for automatic time and date configuration. Click the “Save” button to set and store the address in the unit. Click the “Sync” button to force synchronization of the unit’s time and date with the defined server.

Note: Time synchronization occurs automatically when the unit is first powered on, and every 24 hours afterwards, if an NTP server has already been defined. Synchronization requires a live connection to the internet.

- **Server Time:** Shows the unit’s current time and date.

2) Time Configuration

- **Date & Time:** The unit's time and date can be manually configured here if an internet connection, or NTP server is not available. Click on the calendar icon (📅) to open the time and date configuration screen and select the preferred values. After entering a new time and date, click the "Save" button to store it in the unit and start the clock running.

3) Daylight Saving Time Configuration: Enable or disable the use of DST adjustments for the unit's time.

Note: Enabling Daylight Saving Time while outside the configured DST range will result in no change to the current time.

- **Start Time:** Set the month, week, day and time for the start of DST in the current time zone.
- **End Time:** Set the month, week, day and time for the end of DST in the current time zone.
- **Adjust Time:** Set the amount of time to add when DST is active.

6.5.8 User Config Tab

The WebGUI and Telnet username/password are set on this page. Two management levels are available: “Administrator” and “General User”. The administrator username (“admin”) cannot be changed.

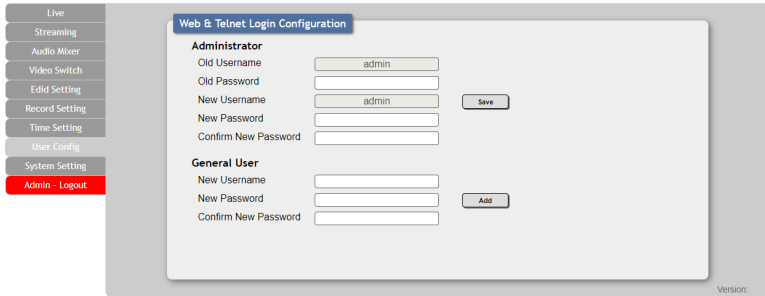

The “Administrator” user has access to all tabs and can change all settings. The “General User” only has access to the “Live” tab to allow easy remote video stream viewing.

6.5.9 System Setting Tab

This tab provides system information, power control, network configuration options, system configuration backup/restore/reset, and firmware update functions.

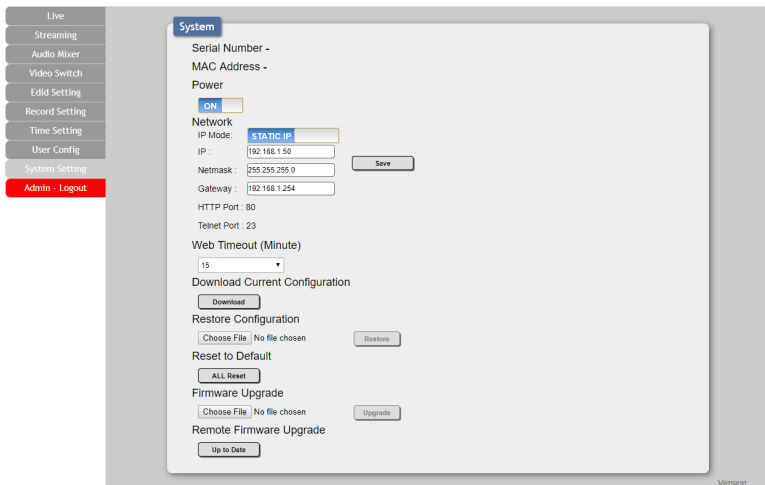

- 1) **Power:** Press this switch to toggle the unit's power between ON and OFF (stand-by mode).

Note: While in standby mode the unit's WebGUI, Telnet and RS232 controls are still active.

- 2) **Network:** IP mode may be switched between Static IP or DHCP. In Static IP mode the IP, netmask and gateway addresses may be manually set. When in DHCP mode, the unit will attempt to connect to a local DHCP server and obtain IP, netmask and gateway addresses automatically. Please press "Save" after making any changes to the IP configuration or mode.

Note: The unit's default IP address is 192.168.1.50. If the IP address is changed then the IP address required for WebGUI/Telnet access will also change accordingly.

- 3) **Web Timeout (Minute):** Select the length of time to wait before logging the user out of the WebGUI due to inactivity. Available range is from 1 to 120 minutes, or disabled.
- 4) **Download Current Configuration:** The current system configuration, including routing and settings, may be saved as an XML file to a PC. Click the "Download" button to save the current system configuration to your local PC.
- 5) **Restore Configuration:** Previously saved system configurations may be restored from a saved XML file. Click the "Choose File" button to locate the saved XML file, then click the "Restore" button.
- 6) **Reset to Default:** Press the "ALL Reset" button to reset the unit to its factory default state. After the reset is complete, the unit will reboot automatically.
- 7) **Firmware Upgrade:** To update the unit's firmware, click the "Choose File" button to open the file selection window and then select the firmware update file (*.bin format) located on your local PC. After selecting the file, click the "Upgrade" button to begin the firmware update process. After the upgrade is complete, the unit will reboot automatically.
- 8) **Remote Firmware Upgrade:** To update this unit's firmware using our cloud based firmware server, click the "Up to Date" button and it will connect to the cloud server and automatically find the latest official firmware version. You will be told the new firmware version number, and you can then choose whether you wish to update to that version or not. After the upgrade is complete, the unit will reboot automatically.

Note: The Remote Firmware Upgrade feature requires a live connection to the internet.

6.6 Telnet Control

Before attempting to use Telnet control, please ensure that both the unit and the PC are connected to the same active networks.

To Access the Command Line Interface (CLI)	
Windows 7	Click Start , type “cmd” in the search field, and press Enter .
Windows XP	Click Start > Run , type “cmd”, and press Enter .
Mac OS X	Click Go > Applications > Utilities > Terminal .

Once in the Command Line Interface (CLI) type “**telnet**” followed by the IP address of the unit (and the port number if it is non-standard) and then hit “**Enter**”. This will connect us to the unit we wish to control.

```
Microsoft Windows [Version 6.1.7601]
Copyright (c) 2009 Microsoft Corporation. All rights reserved.

C:\Users\Administrator>telnet 192.168.1.50 23
```

Note 1: If the IP address is changed then the IP address required for Telnet access will also change accordingly.

Note 2: The default IP address is 192.168.1.50.

COMMAND	
Description and Parameters	
help ↵	Show all available commands.
? ↵	Show all available commands.
get fw ver ↵	Show the unit's current firmware version.
get model name ↵	Show the unit's model name.
get model type ↵	Show the unit's model type.
get command ver ↵	Show the unit's command protocol version.
get mac addr ↵	Show the unit's MAC address.
get user config ↵	List all current user configuration details.
set factory default ↵	Reset the unit to its factory defaults.
set factory ipconfig default ↵	Reset the unit's IP configuration to the factory defaults.
set factory out route default ↵	Reset the unit's routing to the factory defaults.
set system reboot ↵	Reboot the unit.

COMMAND	
Description and Parameters	
set power N1 ↵	
Power the unit on or place it into standby mode.	
Available values for N1 :	
1	[Power on]
2	[Standby mode]
ON	[Power on]
STANDBY	[Standby mode]
get power ↵	
Show the unit's current power state.	
set in N1 name N2 ↵	
Set the name of the specified input.	
Available values for N1 :	
1	[HDMI input]
2	[VGA input]
N2 = {name}	[32 characters max]
get in N1 name ↵	
Show the current name of the specified input.	
set out A name N1 ↵	
Set the name of the HDMI output.	
N1 = {name}	[32 characters max]
get out A name ↵	
Show the current name of the HDMI output.	
get in name list ↵	
List the names of all inputs on the unit.	
get out name list ↵	
List the names of all outputs on the unit.	

COMMAND					
Description and Parameters					
set out auto mode N1 ←	<p>Set the auto switching behavior of the unit.</p> <p>Available values for N1:</p> <table> <tr> <td>0</td> <td>[Disabled]</td> </tr> <tr> <td>1</td> <td>[Auto Switch]</td> </tr> </table>	0	[Disabled]	1	[Auto Switch]
0	[Disabled]				
1	[Auto Switch]				
get out auto mode ←	<p>Show the current auto switching mode of the unit.</p>				
get out auto mode list ←	<p>List all available auto mode options.</p>				
get in N1 hactive ←	<p>Show the horizontal active pixel value of the specified input's current video source.</p> <p>Available values for N1:</p> <table> <tr> <td>1</td> <td>[HDMI input]</td> </tr> <tr> <td>2</td> <td>[VGA input]</td> </tr> </table> <p><i>Note: Values can only be read if the input is currently selected.</i></p>	1	[HDMI input]	2	[VGA input]
1	[HDMI input]				
2	[VGA input]				
get in N1 vactive ←	<p>Show the vertical active pixel value of the specified input's current video source.</p> <p>Available values for N1:</p> <table> <tr> <td>1</td> <td>[HDMI input]</td> </tr> <tr> <td>2</td> <td>[VGA input]</td> </tr> </table> <p><i>Note: Values can only be read if the input is currently selected.</i></p>	1	[HDMI input]	2	[VGA input]
1	[HDMI input]				
2	[VGA input]				
get in N1 refresh rate ←	<p>Show the refresh rate of the specified input's current video source.</p> <p>Available values for N1:</p> <table> <tr> <td>1</td> <td>[HDMI input]</td> </tr> <tr> <td>2</td> <td>[VGA input]</td> </tr> </table> <p><i>Note: Values can only be read if the input is currently selected.</i></p>	1	[HDMI input]	2	[VGA input]
1	[HDMI input]				
2	[VGA input]				

COMMAND					
Description and Parameters					
get in N1 interlace ↵	<p>Show the interlace state of the specified input's current video source.</p> <p>Available values for N1:</p> <table> <tr> <td>1</td> <td>[HDMI input]</td> </tr> <tr> <td>2</td> <td>[VGA input]</td> </tr> </table> <p><i>Note: Values can only be read if the input is currently selected.</i></p>	1	[HDMI input]	2	[VGA input]
1	[HDMI input]				
2	[VGA input]				
get in N1 sync status ↵	<p>Show the current sync state of the specified input.</p> <p>Available values for N1:</p> <table> <tr> <td>1</td> <td>[HDMI input]</td> </tr> <tr> <td>2</td> <td>[VGA input]</td> </tr> </table> <p><i>Note: Values can only be read if the input is currently selected.</i></p>	1	[HDMI input]	2	[VGA input]
1	[HDMI input]				
2	[VGA input]				
get in N1 timing ↵	<p>Show the index number of the current resolution detected on the specified input.</p> <p>Available values for N1:</p> <table> <tr> <td>1</td> <td>[HDMI input]</td> </tr> <tr> <td>2</td> <td>[VGA input]</td> </tr> </table> <p><i>Note: Values can only be read if the input is currently selected.</i></p>	1	[HDMI input]	2	[VGA input]
1	[HDMI input]				
2	[VGA input]				
get in type list ↵	<p>List the port type of all inputs on the unit.</p>				
get out type list ↵	<p>List the port type of all outputs on the unit.</p>				
set all out route N1 ↵	<p>Route the specified input to all outputs.</p> <p>Available values for N1:</p> <table> <tr> <td>1</td> <td>[HDMI input]</td> </tr> <tr> <td>2</td> <td>[VGA input]</td> </tr> </table>	1	[HDMI input]	2	[VGA input]
1	[HDMI input]				
2	[VGA input]				
get all out route ↵	<p>Show the current routing for all outputs.</p>				

COMMAND					
Description and Parameters					
get in port number ↵	Show the total number of inputs on the unit.				
get out port number ↵	Show the total number of outputs on the unit.				
get out A sync status ↵	Show the current sync state of the HDMI output.				
get out timing list ↵	List all available output resolutions with their local index numbers.				
set audio out all mute N1 ↵	<p>Enable or disable muting on all audio outputs.</p> <p>Available values for N1:</p> <table> <tr> <td>ON</td> <td>[Mute enabled]</td> </tr> <tr> <td>OFF</td> <td>[Mute disabled]</td> </tr> </table>	ON	[Mute enabled]	OFF	[Mute disabled]
ON	[Mute enabled]				
OFF	[Mute disabled]				
get audio out A mute ↵	Show the current mute state of the specified output.				
set audio out A route N1 ↵	<p>Route the specified audio input to the HDMI output.</p> <p>Available values for N1:</p> <table> <tr> <td>1</td> <td>[HDMI audio]</td> </tr> <tr> <td>2</td> <td>[Analog audio]</td> </tr> </table>	1	[HDMI audio]	2	[Analog audio]
1	[HDMI audio]				
2	[Analog audio]				
get audio out A route ↵	Show the current audio input routed to the HDMI output.				
get audio in type list ↵	List all available audio input sources.				
get audio out type list ↵	List all available audio output destinations.				

COMMAND					
Description and Parameters					
set audio mixer N1 ↵	<p>Enable or disable the unit's audio mixer function.</p> <p>Available values for N1:</p> <table> <tr> <td>ON</td> <td>[Mixer enabled]</td> </tr> <tr> <td>OFF</td> <td>[Mixer disabled]</td> </tr> </table>	ON	[Mixer enabled]	OFF	[Mixer disabled]
ON	[Mixer enabled]				
OFF	[Mixer disabled]				
get audio mixer	<p>Show the current state of the unit's audio mixer.</p>				
set audio mixer in N1 volume N2 ↵	<p>Set the audio mixer's input volume level for the specified audio source.</p> <p>Available values for N1:</p> <table> <tr> <td>1</td> <td>[HDMI audio]</td> </tr> <tr> <td>2</td> <td>[Analog audio]</td> </tr> </table> <p>N2 = 0~100 [Volume level]</p>	1	[HDMI audio]	2	[Analog audio]
1	[HDMI audio]				
2	[Analog audio]				
get audio mixer in N1 volume ↵	<p>Show the audio mixer's current input volume level for the specified audio source.</p> <p>Available values for N1:</p> <table> <tr> <td>1</td> <td>[HDMI audio]</td> </tr> <tr> <td>2</td> <td>[Analog audio]</td> </tr> </table>	1	[HDMI audio]	2	[Analog audio]
1	[HDMI audio]				
2	[Analog audio]				
set audio mixer out A volume N1 ↵	<p>Set the audio mixer's output volume level.</p> <p>N1 = 0~100 [Volume level]</p>				
get audio mixer out A volume ↵	<p>Show the audio mixer's current output volume level.</p>				

COMMAND	
Description and Parameters	
get all in edid list ↵	List the EDIDs assigned to all inputs.
get internal N1 edid data ↵	Show the specified Internal EDID as HEX data. N1 = 1~6 [Internal EDID number]
set in 1 hdcp mode N1 ↵	Set the HDCP behavior of the HDMI input. Available values for N1 : 0 [Disable HDCP] 1 [Follow source] 2 [Follow display]
get in 1 hdcp mode ↵	Show the current HDCP behavior used by the HDMI input.
get in 1 hdcp status ↵	Show the current HDCP status of the specified input.
get out N1 hdcp status ↵	Show the current HDCP status of the HDMI output. Available values for N1 : A [HDMI output] B [Streaming output]
set out A osd N1 ↵	Enable or disable the OSD Countdown Timer banner. Available values for N1 : ON [OSD on] OFF [OSD off]
get out A osd ↵	Show the current state of the OSD Countdown Timer banner.

COMMAND	
Description and Parameters	
set out N1 banner text N2 ↵	
Set the OSD banner text to use on the specified output.	
Available values for N1 :	
A	[HDMI output]
B	[Streaming output]
N2 = {Banner text}	[29 characters max]
get out N1 banner text ↵	
Show the current OSD banner text used by the specified output.	
Available values for N1 :	
A	[HDMI output]
B	[Streaming output]
set out A banner font size N1 ↵	
Set the font size for the OSD Countdown Timer banner.	
Available values for N1 :	
1	[Normal size]
2	[Double size]
3	[Quadruple size]
get out A banner font size ↵	
Show the current font size for the OSD Countdown Timer banner.	
set out A banner font color N1 ↵	
Set the color of the font used by the OSD Countdown Timer banner.	
Available values for N1 :	
BLACK	[Text color]
WHITE	[Text color]
RED	[Text color]
GREEN	[Text color]
BLUE	[Text color]
MAGENTA	[Text color]
YELLOW	[Text color]
CYAN	[Text color]
GRAY	[Text color]

COMMAND																			
Description and Parameters																			
get out A banner font color ↵	Show the current color of the font used by the OSD Countdown Timer banner.																		
get out banner font color list ↵	List all available font colors for the OSD Countdown Timer banner.																		
set out A banner font transparency level N1 ↵	Set the text transparency level for the OSD Countdown Timer banner. N1 = 1~8 [Transparency level]																		
get out A banner font transparency level ↵	Show the current text transparency level for the OSD Countdown Timer banner.																		
set out A osd background color N1 ↵	Set the color of the background of the OSD Countdown Timer banner. Available values for N1 : <table border="0"> <tr> <td>BLACK</td> <td>[Background color]</td> </tr> <tr> <td>WHITE</td> <td>[Background color]</td> </tr> <tr> <td>RED</td> <td>[Background color]</td> </tr> <tr> <td>GREEN</td> <td>[Background color]</td> </tr> <tr> <td>BLUE</td> <td>[Background color]</td> </tr> <tr> <td>MAGENTA</td> <td>[Background color]</td> </tr> <tr> <td>YELLOW</td> <td>[Background color]</td> </tr> <tr> <td>CYAN</td> <td>[Background color]</td> </tr> <tr> <td>GRAY</td> <td>[Background color]</td> </tr> </table>	BLACK	[Background color]	WHITE	[Background color]	RED	[Background color]	GREEN	[Background color]	BLUE	[Background color]	MAGENTA	[Background color]	YELLOW	[Background color]	CYAN	[Background color]	GRAY	[Background color]
BLACK	[Background color]																		
WHITE	[Background color]																		
RED	[Background color]																		
GREEN	[Background color]																		
BLUE	[Background color]																		
MAGENTA	[Background color]																		
YELLOW	[Background color]																		
CYAN	[Background color]																		
GRAY	[Background color]																		
get out A osd background color ↵	Show the current color of the background of the OSD Countdown Timer banner.																		
get out osd background color list ↵	List all available background colors for the OSD Countdown Timer banner.																		

COMMAND	
Description and Parameters	
set out A countdown timer N1↵	
Set the countdown timer value (in seconds).	
N1 = 0~86400	[Time in seconds]
get out A countdown timer↵	
Show the current countdown timer value.	
set uart 1 baudrate N2↵	
Set the baud rate of the RS-232 port.	
Available values for N1 :	
4800	[Baud rate]
7200	[Baud rate]
9600	[Baud rate]
14400	[Baud rate]
19200	[Baud rate]
38400	[Baud rate]
57600	[Baud rate]
115200	[Baud rate]
get uart 1 baudrate↵	
Show the current baud rate of the RS-232 port.	
get uart list↵	
List all available RS-232 ports.	
set uart 1 reset↵	
Reset the unit's RS-232 settings to the factory defaults.	
set ip mode N1↵	
Set the IP address assignment mode.	
Available values for N1 :	
0	[Static IP mode]
1	[DHCP mode]
STATIC	[Static IP mode]
DHCP	[DHCP mode]
get ip mode↵	
Show the current IP address assignment mode.	

COMMAND	
Description and Parameters	
get ipconfig ↵	Show the unit's current IP configuration information.
set ipaddr N1 ↵	Set the unit's static IP address. N1 = X.X.X.X [X = 0 ~ 255]
get ipaddr ↵	Show the unit's current IP address.
set netmask N1 ↵	Set the unit's static netmask. N1 = X.X.X.X [X = 0 ~ 255]
get netmask ↵	Show the unit's current netmask.
set gateway N1 ↵	Set the unit's static gateway address. N1 = X.X.X.X [X = 0 ~ 255]
get gateway ↵	Show the unit's current gateway address.
set encoder 1 profile N1 resolution N2 ↵	Set the maximum resolution for the specified streaming channel profile. N1 = 2~4 [Streaming channel] Available values for N2 : 1920x1080 [Streaming resolution] 1280x720 [Streaming resolution] 640x480 [Streaming resolution] 320x240 [Streaming resolution]
get encoder 1 profile N1 resolution ↵	Show the current resolution used by the specified streaming channel profile.

COMMAND	
Description and Parameters	
set encoder 1 profile N1 bitrate N2	↵
Set the maximum bitrate (in Kbps) for the specified streaming channel profile.	
N1 = 2~4	[Streaming channel]
N2 = 1~6000	[Max bitrate in Kbps]
get encoder 1 profile N1 bitrate	↵
Show the current maximum bitrate (in Kbps) used by the specified streaming channel profile.	
set encoder 1 profile N1 framerate N2	↵
Set the frame rate for the specified streaming channel profile.	
N1 = 2~4	[Streaming channel]
N2 = 1~60	[Frames per second]
get encoder 1 profile N1 framerate	↵
Show the current frame rate used by the specified streaming channel profile.	
set live stream mode N1	↵
Start or stop live streaming to the pre-set target service.	
Available values for N1 :	
ON	[Start streaming]
OFF	[Stop streaming]
get live stream mode	↵
Show the current state of the live stream to the pre-set target service.	
set live stream url N1	↵
Set the URL used to access the current live streaming target service.	
N1 = {text string}	[Target service Stream URL]
get live stream url	↵
Show the URL used to access the current live streaming target service.	

COMMAND	
Description and Parameters	
set live stream key N1 ↵	
Set the stream key used to authenticate with the current live streaming target service.	
N1 = {text string}	[Target service Stream Key]
get live stream key ↵	
Show the stream key used to authenticate with the current live streaming target service.	
set live encode resolution N1 ↵	
Set the maximum encoding resolution to use with the current live streaming target service.	
Available values for N1 :	
1920x1080	[Streaming resolution]
1280x720	[Streaming resolution]
640x480	[Streaming resolution]
320x240	[Streaming resolution]
get live encode resolution ↵	
Show the encoding resolution used with the current live streaming target service.	
set live encode bitrate N1 ↵	
Set the maximum streaming bitrate (in Kbps) to use with the current live streaming target service.	
N1 = 1~3000	[Max bitrate in Kbps]
get live encode bitrate ↵	
Show the maximum streaming bitrate (in Kbps) used with the current live streaming target service.	
set live encode framerate N1 ↵	
Set the frame rate to use with the current live streaming target service.	
N1 = 1~60	[Frames per second]
get live encode framerate ↵	
Show the frame rate used with the current live streaming target service.	

COMMAND											
Description and Parameters											
set record mode N1 ←	<p>Enable or disable recording.</p> <p>Available values for N1:</p> <table> <tr> <td>ON</td> <td>[Enable recording]</td> </tr> <tr> <td>OFF</td> <td>[Disable recording]</td> </tr> </table>	ON	[Enable recording]	OFF	[Disable recording]						
ON	[Enable recording]										
OFF	[Disable recording]										
get record mode ←	<p>Show the current recording status.</p>										
set record overwrite N1 ←	<p>Enable or disable record overwrite support.</p> <p>Available values for N1:</p> <table> <tr> <td>ON</td> <td>[Enable overwrite support]</td> </tr> <tr> <td>OFF</td> <td>[Disable overwrite support]</td> </tr> </table>	ON	[Enable overwrite support]	OFF	[Disable overwrite support]						
ON	[Enable overwrite support]										
OFF	[Disable overwrite support]										
get record overwrite ←	<p>Show the current state of record overwrite support.</p>										
set record media path N1 ←	<p>Set the target media for recording.</p> <p>Available values for N1:</p> <table> <tr> <td>AUTO</td> <td>[Automatic selection]</td> </tr> <tr> <td>USB</td> <td>[Local recording to USB port]</td> </tr> <tr> <td>SDCARD</td> <td>[Local recording to SD Card slot]</td> </tr> <tr> <td>NFS</td> <td>[Network recording via NFS]</td> </tr> <tr> <td>CIFS</td> <td>[Network recording via CIFS]</td> </tr> </table>	AUTO	[Automatic selection]	USB	[Local recording to USB port]	SDCARD	[Local recording to SD Card slot]	NFS	[Network recording via NFS]	CIFS	[Network recording via CIFS]
AUTO	[Automatic selection]										
USB	[Local recording to USB port]										
SDCARD	[Local recording to SD Card slot]										
NFS	[Network recording via NFS]										
CIFS	[Network recording via CIFS]										
get record media path ←	<p>Show the current recording target media selection.</p>										
set schedule record mode N1 ←	<p>Enable or disable scheduled recording support.</p> <p>Available values for N1:</p> <table> <tr> <td>ON</td> <td>[Enable scheduled recording]</td> </tr> <tr> <td>OFF</td> <td>[Disable scheduled recording]</td> </tr> </table>	ON	[Enable scheduled recording]	OFF	[Disable scheduled recording]						
ON	[Enable scheduled recording]										
OFF	[Disable scheduled recording]										
get schedule record mode ←	<p>Show the current state of scheduled recording support.</p>										

COMMAND**Description and Parameters****set record resolution N1 ↵**

Set the resolution to use when recording to the target media.

Available values for **N1**:

1920x1080	[Streaming resolution]
1280x720	[Streaming resolution]
640x480	[Streaming resolution]
320x240	[Streaming resolution]

get record resolution ↵

Show the currently selected recording resolution.

set record bitrate N1 ↵

Set the maximum bitrate (in Kbps) to use when recording to the target media.

N1 = 1~6000 [Max bitrate in Kbps]

get record bitrate ↵

Show the current maximum recording bitrate (in Kbps).

set record framerate N1 ↵

Set the frame rate to use when recording to the target media.

N1 = 1~60 [Frames per second]

get record framerate ↵

Show the current frame rate used when recording.

Note: Commands will not be executed unless followed by a carriage return. Commands are not case-sensitive.

7. CONNECTION DIAGRAM

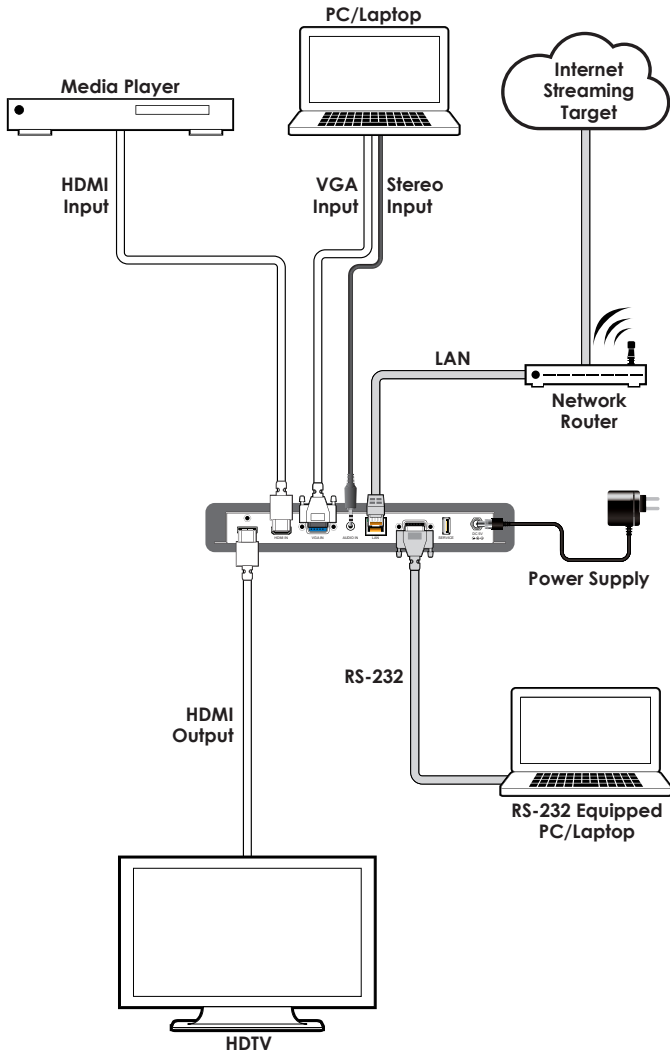

8. SPECIFICATIONS

8.1 Technical Specifications

HDMI Bandwidth	18Gbps
VGA Bandwidth	165MHz
Input Ports	1×HDMI (Type-A) 1×VGA (HD-15) 1×Analog Stereo (3.5mm)
Output Port	1×HDMI (Type-A)
Data Storage	1×Card Slot (Micro SD)
Control/Streaming Port	1×LAN (RJ-45)
Control Port	1×RS-232 (DE-9)
Service Port	1×USB 2.0 (Type-A)
IR Frequency	30 – 50kHz (30 – 60kHz under ideal conditions)
Baud Rate	19200
Power Supply	5V/2.6A DC (US/EU standards, CE/FCC/UL certified)
ESD Protection (HBM)	±8kV (Air Discharge) ±4kV (Contact Discharge)
Dimensions (W×H×D)	231.5mm×25mm×108mm [Case Only] 231.5mm×25mm×117mm [All Inclusive]
Weight	668g
Chassis Material	Metal (Steel)
Chassis Color	Black
Operating Temperature	0°C – 40°C/32°F – 104°F
Storage Temperature	-20°C – 60°C/-4°F – 140°F
Relative Humidity	20 – 90% RH (Non-condensing)
Power Consumption	9.57W

8.2 Video Specifications

Supported Resolutions (Hz)	Streaming Support		Output	
	HDMI Input	VGA Input	HDMI Bypass	H.264 Stream
320×240@25/30/50/60	x	x	x	✓
720×400p@70/85	x	x	✓	x
640×480p@25/30/50	x	x	x	✓
640×480p@60/72/75/85	60	60	✓	60
720×480i@60	x	x	✓	x
720×480p@60	✓	✓	✓	✓
720×576i@50	x	x	✓	x
720×576p@50	✓	✓	✓	✓
800×600p@56/60/72/75/85	60	60	✓	60
848×480p@60	✓	✓	✓	✓
1024×768p@60/70/75/85	60	60	✓	60
1152×864p@75	x	x	✓	x
1280×720p@25/30	✓	✓	x	✓
1280×720p@50/60	✓	✓	✓	✓
1280×768p@60/75/85	60	60	✓	60
1280×800p@60/75/85	60	60	✓	60
1280×960p@60/85	60	60	✓	60
1280×1024p@60/75/85	60	60	✓	60
1360×768p@60	✓	x	✓	✓
1366×768p@60	✓	✓	✓	✓
1400×1050p@60	x	x	✓	x
1440×900p@60/75	60	60	✓	60
1600×900p@60RB	✓	x	✓	✓
1600×1200p@60	✓	✓	✓	x
1680×1050p@60	✓	✓	✓	✓

Supported Resolutions (Hz)	Streaming Support		Output	
	HDMI Input	VGA Input	HDMI Bypass	H.264 Stream
1920×1080i@50/60	x	x	✓	x
1920×1080p@24/25/30	✓	✓	✓	25/30
1920×1080p@50/60	✓	✓	✓	✓
1920×1200p@60RB	x	x	✓	x
2560×1440p@60RB	x	x	✓	x
2560×1600p@60RB	x	x	✓	x
2048×1080p@24/25/30	x	x	✓	x
2048×1080p@50/60	x	x	✓	x
3840×2160p@24/25/30	✓	x	✓	x
3840×2160p@50/60 (4:2:0)	✓	x	✓	x
3840×2160p@24, HDR10	x	x	✓	x
3840×2160p@50/60 (4:2:0), HDR10	x	x	✓	x
3840×2160p@50/60	✓	x	✓	x
4096×2160p@24/25/30	✓	x	✓	x
4096×2160p@50/60 (4:2:0)	✓	x	✓	x
4096×2160p@24, HDR10	x	x	✓	x
4096×2160p@50/60 (4:2:0), HDR10	x	x	✓	x
4096×2160p@50/60	✓	x	✓	x

8.3 Audio Specifications

8.3.1 Digital Audio

HDMI Input / Output	
LPCM	
Max Channels	8 Channels
Sampling Rate (kHz)	32, 44.1, 48, 88.2, 96, 176.4, 192
Bitstream (Bypass only)	
Supported Formats	Standard & High-Definition
Streaming Output	
LPCM	
Max Channels	2 Channels
Sampling Rate (kHz)	44.1, 48
Bitstream	
Supported Formats	None

8.3.2 Analog Audio

Analog Input	
Max Audio Level	2Vrms
Impedance	20k Ω
Type	Unbalanced

8.4 Cable Specifications

Cable Length	1080p		4K30	4K60
	8-bit	12-bit	(4:4:4) 8-bit	(4:4:4) 8-bit
High Speed HDMI Cable				
HDMI Input	5m	5m	5m	2m
HDMI Output	5m	5m	5m	2m
VGA Cable				
VGA Input	2m		x	
Ethernet Cable				
Cat.5e/6	100m	x		
Cat.6a/7	100m	x		

Bandwidth Category Examples:

- **1080p (FHD Video)**
 - Up to 1080p@60Hz, 12-bit color
 - Data rates lower than 5.3Gbps or below 225MHz TMDS clock
- **4K30 (4K UHD Video)**
 - 4K@24/25/30Hz & 4K@50/60Hz (4:2:0), 8-bit color
 - Data rates higher than 5.3Gbps or above 225MHz TMDS clock but below 10.2Gbps
- **4K60 (4K UHD+ Video)**
 - 4K@50/60Hz (4:4:4, 8-bit)
 - 4K@50/60Hz (4:2:0, 10-bit HDR)
 - Data rates higher than 10.2Gbps

9. ACRONYMS

ACRONYM	COMPLETE TERM
Cat.5e	Enhanced Category 5 cable
Cat.6	Category 6 cable
Cat.6A	Augmented Category 6 cable
Cat.7	Category 7 cable
CLI	Command-Line Interface
CIFS	Common Internet File System
DHCP	Dynamic Host Configuration Protocol
EDID	Extended Display Identification Data
GUI	Graphical User Interface
HDCP	High-bandwidth Digital Content Protection
HDMI	High-Definition Multimedia Interface
HDR	High Dynamic Range
IP	Internet Protocol
LAN	Local Area Network
LED	Light-Emitting Diode
LPCM	Linear Pulse-Code Modulation
NAS	Network Attached Storage
NFS	Network File System
OSD	On-Screen Display
SNTP	Simple Network Time Protocol
TCP	Transmission Control Protocol
4K UHD	4K Ultra-High-Definition (10.2Gbps max)
4K UHD⁺	4K Ultra-High-Definition (18Gbps max)
USB	Universal Serial Bus
Ω	Ohm



CYPRESS TECHNOLOGY CO., LTD.
www.cypress.com.tw
