

**FAN Unit**

**RF-4**

---

<User Guide>

Ver.1.0.0

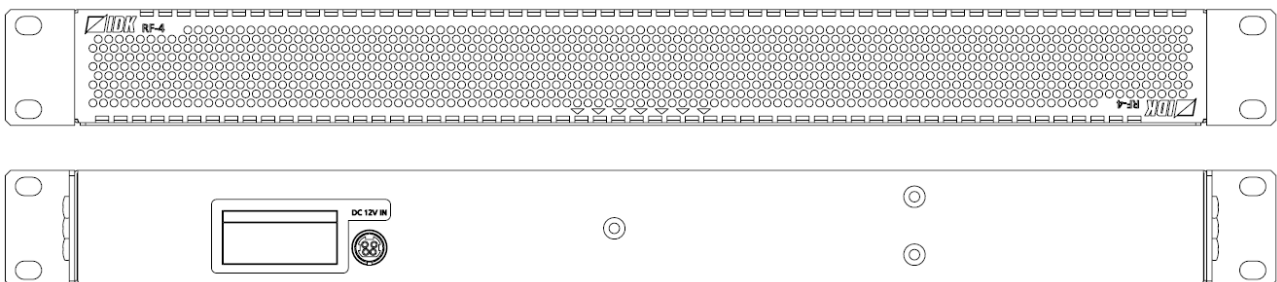

- Thank you for choosing our product.
- To ensure the best performance of this product, please read this user guide fully and carefully before using it and keep this manual together with the product for future reference as needed.

**IDK Corporation**

## **Trademarks**

- All other company and product names mentioned in this manual are either registered trademarks or trademarks of their respective owners. In this manual, the “®” or “™” marks may not be specified.

## Before reading this manual

- All rights reserved.
- Some information contained in this document may differ depending on the product version.
- This User guide is subject to change without notice. You can download the latest version from IDK's website at: <http://www.idkav.com>

### FCC STATEMENT

This equipment has been tested and found to comply with the limits for a Class A digital device, pursuant to part 15 of the FCC Rules. These limits are designed to provide reasonable protection against harmful interference when the equipment is operated in a commercial environment. This equipment generates, uses, and can radiate radio frequency energy and, if not installed and used in accordance with the instruction manual, may cause harmful interference to radio communications. Operation of this equipment in a residential area is likely to cause harmful interference, in which case the user will be required to correct the interference at his own expense.

### CE MARKING

This equipment complies with the essential requirements of the relevant European health, safety and environmental protection legislation.

### WEEE MARKING











Waste Electrical and Electronic Equipment (WEEE), Directive 2002/96/EC  
(This directive is only valid in the EU.)

This equipment complies with the WEEE Directive (2002/96/EC) marking requirement.  
The left marking indicates that you must not discard this electrical/electronic equipment in domestic household waste.

# Safety Instructions

Read and understand all safety and operating instructions before using this product. Follow all instructions and heed all warnings/cautions.

Enforcement Symbol	Description
 <b>Warning</b>	Indicates the presence of a hazard that may result in death or serious personal injury if the warning is ignored or the product is handled incorrectly.
 <b>Caution</b>	Indicates the presence of a hazard that may cause minor personal injury or property damage if the caution is ignored or the product is handled incorrectly.



Symbol	Description	Example
 Caution	This symbol is intended to alert the user. (Warning and caution)	 Electrical Hazard
 Prohibited	This symbol is intended to prohibit the user from specified actions.	 Do not disassemble
 Instruction	This symbol is intended to instruct the user.	 Unplug

## Warning





### ■ For lifting heavy products:

 <b>Instruction</b>	<ul style="list-style-type: none"> <li>● <b>Lifting must be done by two or more personnel.</b></li> </ul> <p>To avoid injury: When lifting the product, bend your knees, keep your back straight and get close to it with two or more persons.</p>
---	--

### ■ For installing and connecting products:

 <b>Prohibited</b>	<ul style="list-style-type: none"> <li>● <b>Do not place the product upon a surface that may give way or that may become unstable.</b></li> </ul> <p>Install the product in a secure and stable place to prevent it from falling and possibly causing injury.</p> <ul style="list-style-type: none"> <li>● <b>Secure the product if installing in locations prone to vibration or movement.</b></li> </ul> <p>Otherwise, it may move unexpectedly or it may fall and lead to injury.</p>
 <b>Instruction</b>	<ul style="list-style-type: none"> <li>● <b>Installation work must be performed by professionals.</b></li> </ul> <p>The product is intended to be installed by skilled technicians. For installation, please contact a system integrator or IDK. Improper installation may lead to the risk of fire, electric shock, injury, or property damage.</p> <ul style="list-style-type: none"> <li>● <b>Insert the power plug into an outlet that is unobstructed.</b></li> </ul> <p>Unobstructed access to the plug enables unplugging the product in case of any extraordinary failure, abnormal situation or for easy disconnection during extended periods of non-use.</p> <ul style="list-style-type: none"> <li>● <b>Insert the power plug into an appropriate outlet completely.</b></li> </ul> <p>If the plug is partially inserted, arcing may cause the connection to overheat, increasing the risk of electrical shock or fire. Do not use a damaged plug or connect to a damaged outlet.</p> <ul style="list-style-type: none"> <li>● <b>Unplug the product from the AC power source during installation or service.</b></li> </ul> <p>When connecting peripheral devices to this product, unplug all involved devices from outlets. Ground potential differences may cause fire or other difficulties.</p>

### ■ For operating products:

 <b>Prohibited</b>	<ul style="list-style-type: none"> <li>● <b>Keep out any foreign objects.</b></li> </ul> <p>To avoid fire or electric shock, do not permit foreign objects, such as metal and paper, to enter the product from vent holes or other apertures.</p> <ul style="list-style-type: none"> <li>● <b>For power cable/ plug:</b></li> </ul> <ul style="list-style-type: none"> <li>• Do not scratch, heat, or modify, including splicing or lengthening them.</li> <li>• Do not pull, place heavy objects on them, or pinch them.</li> <li>• Do not bend, twist, tie or clamp them together forcefully.</li> </ul> <p>Misuse of the power cable and plug may cause fire or electric shock. If power cables/plugs become damaged, contact your IDK representative.</p>
 <b>Do not disassemble</b>	<ul style="list-style-type: none"> <li>● <b>Do not repair, modify or disassemble.</b></li> </ul> <p>Since the product includes circuitry that uses potentially lethal, high voltage levels, disassembly by unauthorized personnel may lead to the risk of fire or electric shock. For internal inspection or repair, contact your IDK representative.</p>
 <b>Do not touch</b>	<ul style="list-style-type: none"> <li>● <b>Do not touch the product and connected cables during electrical storms.</b></li> </ul> <p>Contact may cause electric shock</p>
 <b>Instruction</b>	<ul style="list-style-type: none"> <li>● <b>Clean the power plug regularly.</b></li> </ul> <p>If the plug is covered in dust, it may increase the risk of fire.</p>

# Warning

■ **If the following problem occurs:**



**Unplug**

- **Unplug immediately if the product smokes, makes unusual noise, or produces a burning odor.**

If you continue to use the product under these conditions, it may cause electric shock or fire.

- **Unplug immediately if the product is damaged by falling or having been dropped.**

If you continue to use the product under these conditions, it may increase the risk of electrical shock or fire. For maintenance and repair, contact your IDK representative.



- **Unplug immediately if water or other objects are directed inside.**

If you continue to use the product under these conditions, it may increase the risk of electrical shock or fire. For maintenance and repair, contact your IDK representative.





# Caution

## ■ For installing and connecting products:

 <p><b>Prohibited</b></p>	<ul style="list-style-type: none"> <li>● <b>Do not place the product in a location where it will be subjected to high temperatures.</b> If the product is subjected to direct sunlight or high temperatures while under operation, it may affect the product's performance and reliability and may increase the risk of fire.</li> <li>● <b>Do not store or operate the product in dusty, oil smoke filled, or humid place.</b> If the product is placed near humidifiers or in a dusty area, it may increase the risk of fire or electric shock.</li> <li>● <b>Do not block the vent holes.</b> If ventilation slots are blocked, it may cause the product to overheat, affecting performance and reliability and may increase the risk of fire.</li> <li>● <b>Do not place or stack heavy items on the product.</b> Failure to observe this precaution may result in damage to the product and other property and may lead to the risk of personal injury.</li> <li>● <b>Do not exceed ratings of outlet and wiring devices.</b> Exceeding the rating of an outlet may increase the risk of fire and electric shock.</li> </ul>
 <p><b>No wet hands</b></p>	<ul style="list-style-type: none"> <li>● <b>Do not handle power plug with wet hands.</b> Failure to observe this precaution may increase the risk of electrical shock.</li> </ul>
 <p><b>Instruction</b></p>	<ul style="list-style-type: none"> <li>● <b>Use and store the product within the specified temperature/humidity range.</b> If the product is used outside the specified range for temperature and humidity continuously, it may increase the risk of fire or electric shock.</li> <li>● <b>Do not place the product at elevations of 1.24 mi. (2,000 m) or higher above sea level.</b> Failure to do so may shorten the life of the internal parts and result in malfunctions.</li> <li>● <b>When mounting the product into the rack, provide sufficient cooling space.</b> Mount the product in a rack meeting EIA standards, and maintain spaces above and below for air circulation. For your safety as required, attach an L-shaped bracket in addition to the panel mount bracket kit to improve mechanical stability.</li> <li>● <b>Never insert screws without the rubber feet into the threaded holes on the bottom of the product.</b> Never insert screws without the rubber feet into the threaded holes on the bottom of the product. Doing so may lead to damage when the screws contact electrical circuitry or components inside the product. Reinstall the originally supplied rubber feet using only the originally supplied screws.</li> </ul>

## ■ For operating products:

 <p><b>Prohibited</b></p>	<ul style="list-style-type: none"> <li>● <b>Use only the supplied power cable and AC adapter.</b></li> <li>● <b>Do not use the supplied power cable and AC adapter with other products.</b> If non-compliant adapter or power cables are used, it may increase the risk of fire or electrical shock.</li> </ul>
 <p><b>Unplug</b></p>	<ul style="list-style-type: none"> <li>● <b>If the product won't be used for an extended period of time, unplug it.</b> Failure to observe this precaution may increase the risk of fire.</li> <li>● <b>Unplug the product before cleaning.</b> To prevent electric shock.</li> </ul>
 <p><b>Instruction</b></p>	<ul style="list-style-type: none"> <li>● <b>If cooling fan stops, power off the product and contact us.</b> Failure to do so may rise internal temperature and increase the risk of malfunction, fire, or electric shock.</li> <li>● <b>Keep vents clear of dust.</b> If the vent holes near the cooling fan or near the fan are covered with dust, internal temperature rises and it may increase the risk of malfunction. Clean the vent holes and near the fan as needed. If dust accumulates inside of the product, it may increase the risk of malfunction, fire, or electric shock. Periodic internal cleaning, especially before humid rainy season, is recommended. For internal cleaning, contact your IDK representative.</li> </ul>

## Table of Contents

---

1 Included Items .....	9
2 About RF-4 .....	10
3 Panels .....	10
4 Installation.....	11
4.1 Precautions .....	11
4.2 Rack mounting brackets .....	11
5 DIN plug AC adapter with locking mechanism .....	12
6 Product specification.....	13



# 1 Included Items

Ensure all items below are included in the package.  
If any items are missing or damaged, please contact IDK.

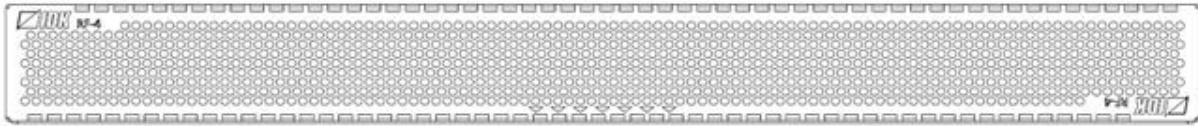

One (1) main unit (RF-4)

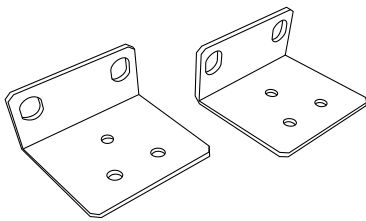

Two (2) rack mounting brackets

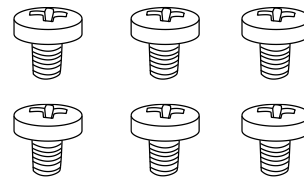

Six (6) M4 screws

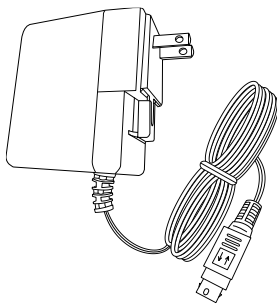

One (1) DIN plug AC adapter with locking mechanism  
(4 ft. (1.2 m))

**[Fig. 1.1] Included items**

## 2 About RF-4

The RF-4 is a cooling fan unit that can be mounted to the rack to avoid rise in internal rack temperature. The fan unit offers the ideal airflow: Intake from the front panel; exhaust from bottom or top panel.

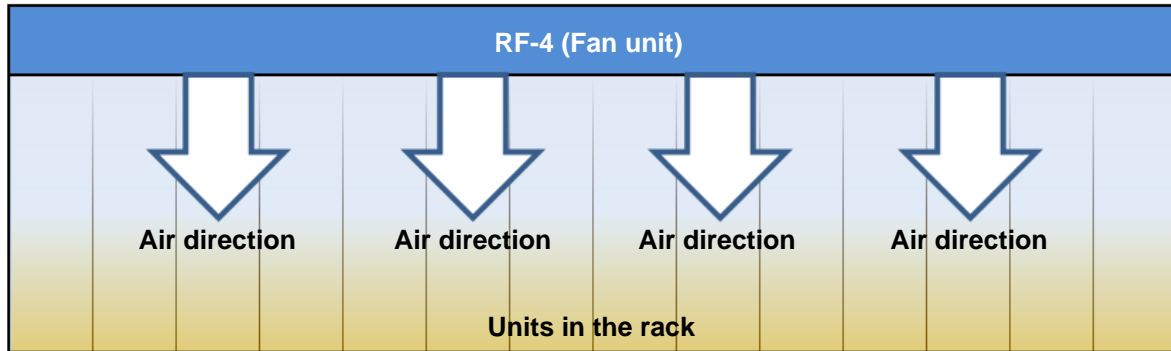

[Fig. 2.1] Airflow

## 3 Panels

### ● Front panel/Bottom panel

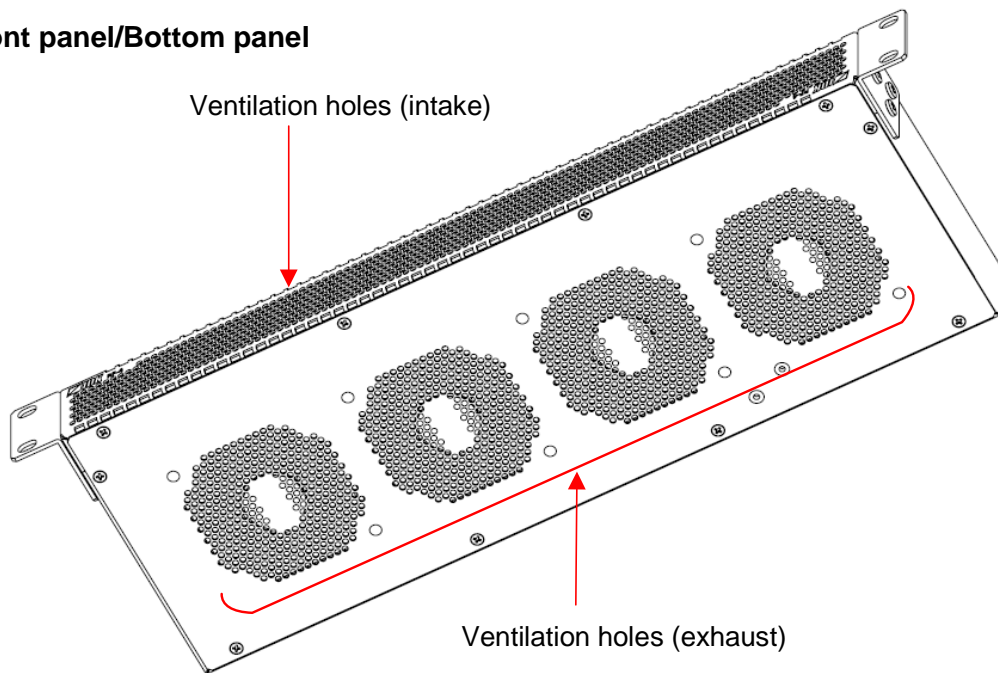

### ● Rear panel



[Fig. 3.1] RF-4 drawing

## 4 Installation

---

### 4.1 Precautions

---

When installing the RF-4, observe the following precautions; otherwise, the internal temperature increases and it may affect the product lifetime and operation.

- Do not block vent holes.
- Consider installing the RF-4 in an environment compatible with the maximum temperature indicated in the specification sheet 32°F to 104°F (0°C to +40°C) (P.13).

### 4.2 Rack mounting brackets

---

Attach the rack mounting brackets to the RF-4 chassis using the supplied M4 screws. The standard screw tightening torque is 1.47 N·m (about 15.0 kgf·cm).

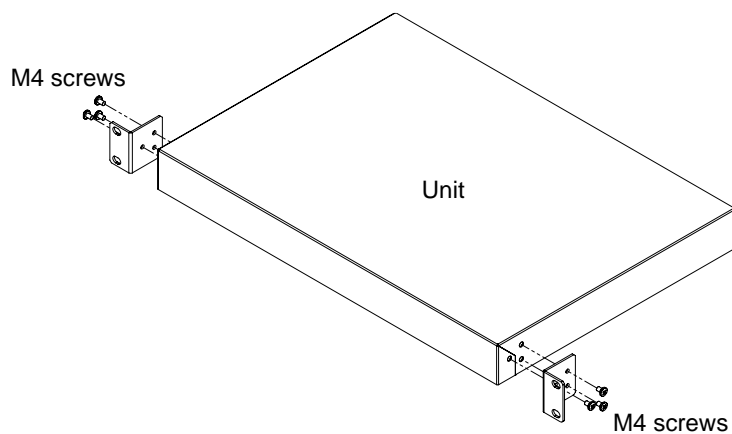

**[Fig. 4.1] Attaching rack mounting brackets**

Attach the RF-4 to the rack without space between the RF-4 and units in order to maximize the cooling function.

**Note:**

If the unit with the RF-4 attached is moved, it may be damaged.

## 5 DIN plug AC adapter with locking mechanism

The shapes of AC plugs with screw locking mechanism vary from country to country. The AC plug can be removed from the AC adapter.

### Removing AC plug:

Slide the AC plug (②) from the AC adapter while holding down the portion mentioned below (①)

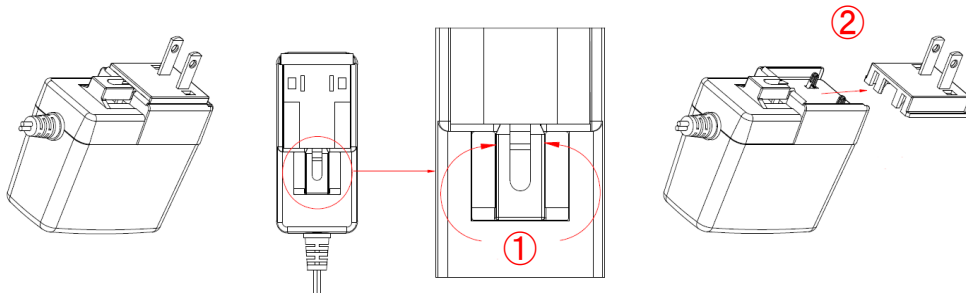

[Fig. 5.1] Removing AC plug (Example: Plug type A)

### Attaching AC plug:

Gently slide the AC plug into the AC adapter (③) until it clicks (④)

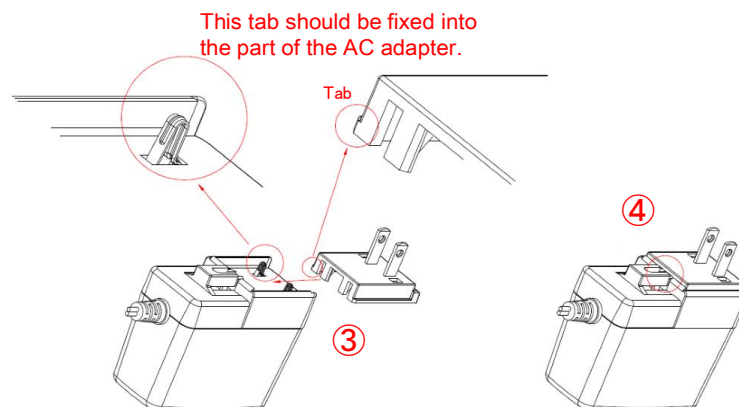

[Fig. 5.2] Attaching AC plug (Example: Plug type A)

### ■ Plugging and unplugging DC plug

Plug the DC plug to the power supply connector of the unit until it clicks  
Hold the portion mentioned below when unplugging the DC plug

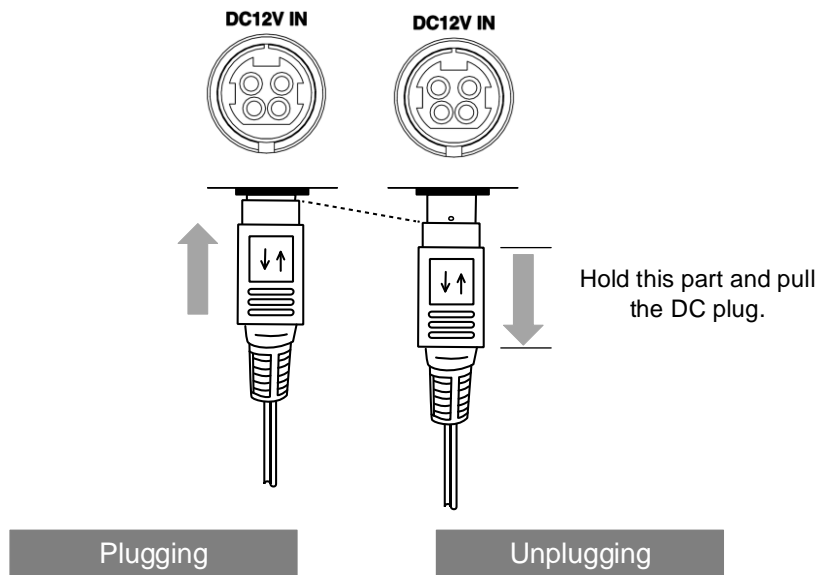

[Fig. 5.3] Plugging and unplugging DC plug

## 6 Product specification

Item		Description
Airflow		1.42 m <sup>3</sup> /min (50 CFM)
General	AC adapter	Input : 100 - 240 VAC ±10%, 50 Hz/60 Hz ±3 Hz Output : DC 12 V 3 A (A dedicated AC adapter is provided)
	Power consumption	About 4 Watts
	Dimensions	16.9 (W) × 1.7 (H) × 5.9 (D)" (430 (W) × 44 (H) × 150 (D) mm) (Excluding connectors and the like)
	Weight	3.5 lbs. (1.6 kg)
	Temperature	Operating : 32°F to 104°F (0°C to +40°C) Storage : -4°F to +176°F (-20°C to +80°C)
Humidity		Operating/Storage: 20% to 90% (Non Condensing)

## User Guide of RF-4

Ver.1.0.0

Issued on: 4 January 2021

---



### Headquarters

IDK Corporation  
7-9-1 Chuo, Yamato-shi, Kanagawa-pref.  
242-0021 JAPAN  
TEL: +81-46-200-0764 FAX: +81-46-200-0765

Email: [idx\\_eng@idx.co.jp](mailto:idx_eng@idx.co.jp)

URL: <http://www.idxkav.com>

### USA

IDK America Inc.  
72 Grays Bridge Road Suite 1-C, Brookfield, CT 06804  
TEL: +1-203-204-2445

Email: [sales@idxkav.com](mailto:sales@idxkav.com)

URL: <http://www.idxkav.com>

### Europe

IDK Europe GmbH  
Lise-Meitner-Str. 6, D-40878 Ratingen  
TEL: +49-2102-578-301-0

Email: [info@idxkav.eu](mailto:info@idxkav.eu)

URL: <http://www.idxkav.com>



### Product information Support

Arvanics Corporation  
7-9-1 Chuo, Yamato-shi, Kanagawa-pref.  
242-0021 JAPAN  
TEL: +81-46-259-6920 FAX: +81-46-259-6930

Email: [info@arvanics.com](mailto:info@arvanics.com)

URL: <http://www.arvanics.com>

Information in this document is subject to change without notice.

©2021 IDK Corporation, all rights reserved. All trademarks mentioned are the property of their respective owners.